



Life Sciences

Validation Guide

USTR 3008

Allegro™ TK8 Film



Contents

A. General description of the Allegro TK8 film	5
B. Properties of the Allegro TK8 film	6
B1. Mechanical testing	6
B1.1. Gelbo	6
B1.2. Strength and elongation	6
B1.3. Puncture resistance.....	6
B1.4. Dart impact	6
B1.5. Tear resistance	6
B2. Physical testing	6
B2.1. O ₂ transmission rate	6
B2.2. CO ₂ transmission rate	6
B2.3. Water vapor transmission rate.....	6
B3. Chemical and biological testing	7
B3.1. Bacterial endotoxin USP <85>	7
B3.2. Biological reactivity – <i>in vitro</i> – ISO 10993-5 and USP <87>	7
B3.3. Biological reactivity – <i>in vivo</i> – ISO 10993-11, ISO 10993-10, ISO 10993-6 and ---USP <88>	7
B4. Physicochemical tests	7
B4.1. Tests on plastic materials and components used to package medical articles USP <661>.....	7
B4.2. Tests on plastic containers for aqueous solutions for parenteral infusion EP 3.2.2.1	7
B5. Functional testing	8
B5.1. Accelerated ageing	8
B5.2. Sterilization validation	8
B5.3. Freezing study.....	8
B6. Overview testing results	8
B6.1. Mechanical results.....	8
B6.1.1. Gelbo	8
B6.1.2. Strength and elongation	9
B6.1.3. Puncture resistance	9
B6.1.4. Dart impact.....	9
B6.1.5. Tear resistance	9
B6.2. Physical testing	10
B6.2.1. O ₂ transmission rate	10
B6.2.2. CO ₂ transmission rate	10
B6.2.3. Water vapor transmission rate	10
B6.3. Chemical and biological testing	10
B6.3.1. Bacterial endotoxin USP <85>	10
B6.3.2. Biological reactivity – <i>in vitro</i> – ISO 10993-5 and USP <87>	10
B6.3.3. Biological reactivity – <i>in vivo</i> – ISO 10993-11, ISO 10993-10, ISO 10993-6 and <88>	10

B6.4. Physicochemical test results	11
B6.4.1. Tests on plastic materials and components used to package medical articles USP <661>	11
B6.4.2. Tests on plastic containers for aqueous solutions for parenteral infusion EP 3.2.2.1	11
B6.4.3. Tests on polyethylene with additives for containers for parenteral preparations and for ophthalmic preparations EP 3.1.5	11
B6.5. Functional testing	11
B6.5.1. Accelerated ageing	11
<i>B6.5.1.1 Accelerated ageing tests on film properties.....</i>	11
<i>B6.5.1.2 Accelerated ageing tests on weld properties.....</i>	13
B6.5.2. Sterilization validation	14
B6.5.3. Freezing study.....	14
C. Extractables and leachables data of the Allegro TK8 film.....	16
C1. Extractables study	17
C1.1. Introduction	17
C1.2. Study purpose	17
C1.3. Results of extractables study	18
C2. Leachables studies.....	19
C2.1. Introduction	19
C2.2. Study purpose	20
C2.3. Test methods	20
C2.3.1. pH	20
C2.3.2. Conductivity	20
C2.3.3. TOC	20
C2.3.4. Metals.....	21
C2.3.5. Volatile organic compounds via purge- and trap GC/MS	21
C2.3.6. Semi-volatile organic compounds via dichloromethane extraction + GC/MS.....	21
C2.3.7. Non-volatile organic compounds via dichloromethane extraction + LC/MS.....	22
C2.4. Evolution of pH with time	22
C2.5. Evolution of conductivity with time	23
C2.6. Evolution of TOC with time	23
C2.7. Evolution of metals with time	24
C2.8. Evolution of extracted components with time	24
C2.9. General conclusion of leachables studies	26
C2.10. Summary of results.....	26
C2.11. Leachables study full results.....	33
C2.11.1. Test solution WFI	33
C2.11.2. Test solution Ethanol 20%	33
C2.11.3. Test solution HCl.....	33
C2.11.4. Test solution NaOH.....	33
C2.11.5. Test solution NaCl.....	33
C2.11.6. Test solution DMSO 10%	33
C2.11.7. Test solution Tween 0.1%	33

D. Chemical Compatibility Test	33
D1. Study purpose	33
D2. Test methods	33
D3. Test solutions	34
D4. Results of the chemical compatibility tests	34
E. Statement on TSE/BSE and animal derived components	37

A. General description of the Allegro TK8 film

The Allegro TK8 film is constructed from laminated layers of PA (polyamide), EVOH (ethylene vinyl alcohol polymer) and ULDPE (ultra low density polyethylene). The outer PA layer provides robust puncture resistance, strength, and excellent thermal stability. The EVOH layer minimizes gas diffusion across the film while maintaining a very good flex crack resistance. The ULDPE layers provide flexibility, integrity and an ultra-clean, ultra-pure, low-extractables product contacting layer.

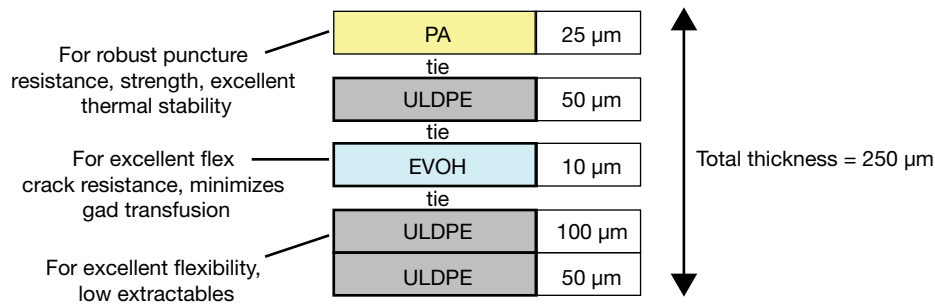

- PA layer
 - Polyamide layer:
 - Mainly used as heat resistant layer that provides additional strength, puncture resistance, impact and tear resistance to the film.
- EVOH layer:
 - Ethylene vinyl alcohol
 - Minimizes gas diffusion
 - Good flex crack resistance
- Tie layers:
 - Are required to bond the various film layers.
- ULDPE layer:
 - Ultra Low Density Polyethylene
 - Contributes to a soft, transparent and extreme flexible film also resulting in a very low level of extractables.
 - Very good water vapor transmission rate.

B. Properties of the Allegro TK8 film

B1. Mechanical Testing

Test type and general description	Standard	Summary description of standard
B1.1. Gelbo flex Determines the flex resistance of materials by the formation of pinholes	ASTM F392-93	This test covers the flex crack resistance of materials by the formation of pinholes. Specimen (=sealed film tube) are twisted and horizontally folded at a constant rate and at different test cycles: 500, 1000, 5000 or 10000 test cycles. The number of pinholes is measured by filling the tube with H ₂ O.
B1.2. Strength and elongation A measure of the force required to stretch a material to its breaking point	ASTM D882-91	This test method covers the determination of tensile properties of plastics in the form of thin sheeting, including film, less than 1.0 mm (0.04 in.) thick.
B1.3. Puncture resistance Puncture resistance testing predicts the durability of the film while in use. Films with high puncture resistance correspond with material that can absorb the energy of an impact by both resistance to deformation and increased elongation. Puncture resistance, measured in energy units, evaluates the film strength and extensibility properties.	FTMS 101B	A pressing bar with a fixed diameter will be pushed through the film at a constant speed. The pressure force, needed to break the film, will indicate the puncture resistance of the film.
B1.4. Dart impact Test method covers the determination of the energy that causes plastic film to fail under specified conditions of impact of a free-falling dart.	ASTM D1709-01B	Described are two testing methods depending on the size of the striker, which are determined by the impact resistance of the material. The standard technique is a staircase method to drop a weight and increase or decrease depending in pass or fail. Standard apparatus and striker has been described.
B1.5. Tear resistance Determines the tear resistance of flexible plastic film.		Test is designed to measure the force to propagate tearing.

B2. Physical Testing

Test type	Standard	Summary description of standard
B2.1. O₂ transmission rate	ASTM F-1927 23 °C, 90% RH inside 50% RH outside	Determines the steady-state rate of transmission of O ₂ gas through material at a given temperature and relative humidity.
B2.2. CO₂ transmission rate	ASTM F-2476 23 °C, 0% RH	Determines the steady-state rate of transmission of CO ₂ gas through material at a given temperature and relative humidity.
B2.3. Water vapor transmission rate	ASTM F-1249 23 °C, 100% RH inside, 0% RH outside	Uses an infrared sensor to measure water vapor permeability at 23 °C with 0% RH on the outside and 100% RH on the inside to simulate worst-case use conditions for a fluid storage container.

B3. Chemical and Biological Testing

Test type and general description	Standard	Summary description of standard
B3.1. Bacterial endotoxin Evaluates the presence of bacterial endotoxins in or on a sample	USP <85>	Limulus amoebocyte lysate (LAL) testing is used to detect or quantify bacterial endotoxins that may be present in or on the sample of the article.
B3.2. Biological reactivity – <i>in vitro</i> Evaluates the response of mammalian cell cultures to extracts of polymeric materials.	USP <87> ISO 10993-5	Results are obtained by placing the test and control materials (extracts) in separate cell culture media under standard conditions. Cells are observed for visible signs of toxicity (such as change in size or appearance of cellular components or a disruption in their configuration) in response to the test and control materials.
B3.3. Biological reactivity – <i>in vivo</i> Evaluates the response in animals to exposure of polymeric materials.	USP <88> ISO 10993-11 ISO 10993-10 ISO 10993-6	USP Biological Reactivity Test – <i>in vivo</i> for Class VI Plastics, is a series of three tests: systemic toxicity, intracutaneous reactivity and implantation. The first two are designed to determine the systemic and local, respectively, biological responses of animals to plastics and other polymers by the single dose injection of specific extracts prepared from a sample. The implantation test is designed to evaluate the reaction of living tissue to the plastic and other polymers by the implantation of the sample itself into animal tissue.

B4. Physicochemical Tests

Test type and general description	Standard	Summary description of standard
B4.1. Tests on plastic materials and components used to package medical articles Evaluates the physical and chemical properties of plastics and their extracts.	USP <661>	Material dependent: measures the properties of impurities extracted from plastics when leached with extraction medium over a specified period and temperature. Includes the following: heavy metals, buffer capacity, and non-volatile residue.
B4.2. Tests on plastic containers for aqueous solutions for parenteral infusion	EP 3.2.2.1	UPW is placed in a container and then extracted. Appearance of solution, acidity or alkalinity, absorbance, reducing substances and transparency are evaluated.

B5. Functional Testing

Test type and general description	Standard	Summary description of standard
B5.1. Accelerated ageing	ASTM F1980-02	Provides information for developing accelerated ageing protocols to rapidly determine the effects, if any, due to the passage of time and environmental conditions on the packaging material. These data can be used to define or support shelf-life. They address the primary package as a whole and do not address the package/product interaction.
B5.2. Sterilization validation Sterilization of healthcare products	ISO 11137	Validates the minimum gamma irradiation dosage necessary to claim sterility at 10 ⁻⁶ sterility assurance level (SAL), based on the bioburden level of the fluid path of the finished products.
B5.3 Freezing study		Test on the effect of freezing at -70 °C on Allegro 2D TK8 biocontainers.

B6. Overview testing results

B6.1. Mechanical results

The following mechanical properties were investigated; flex crack resistance (gelbo test), tensile strength and elongation, film modulus, puncture resistance, dart impact and tear resistance. The tests were carried out before and after gamma irradiation. The utilized level of gamma irradiation was 50 kGy.

B6.1.1. Gelbo

	Before gamma TK8 lot 146051	Before gamma TK8 lot 148048	After gamma TK8 lot 146051	After gamma TK8 lot 148048
Results after 500 cycles				
Average # pinholes	0	not done	0	0
Results after 1000 cycles				
Average # pinholes	0.3	0	1	0.7
Results after 5000 cycles				
Average # pinholes	6.3	3.3	8.7	8.7
Results after 10000 cycles				
Average # pinholes	not done	7	not done	not done

Commentary

The flex crack resistance (gelbo test) was evaluated at 3 out of 4 different test cycles (500, 1000, 5000 and 10 000), depending on the number of cycles at which a zero value was obtained.

B6.1.2. Strength and Elongation

	Before gamma TK8 lot 146051	Before gamma TK8 lot 148048	After gamma TK8 lot 146051	After gamma TK8 lot 148048
Tensile and elongation				
Max strength (MPa) - MD	29	31	25	28
Max strength (MPa) - TD	23	34	25	32
Elongation at break (%) - MD	140	130	250	129
Elongation at break (%) - TD	50	100	160	102
Young Mod (MPa) - MD	590	530	590	620
Young Mod (MPa) - TD	590	490	500	540

Commentary

The reported strength, elongation and modulus data are averages of at least 5 measurements in both film directions. “MD” is the machine direction of the film and “TD” is the transverse machine direction.

B6.1.3. Puncture Resistance

	Before gamma TK8 lot 146051	Before gamma TK8 lot 148048	After gamma TK8 lot 146051	After gamma TK8 lot 148048
Puncture resistance				
Max load (N)	130	136	130	130
Deflection at max load (mm)	9	10	9	9

Commentary

The puncture resistance of the films is expressed in Max load and Deflection at Max load. Both reported values are averages of at least 10 measurements.

B6.1.4. Dart Impact

	Before gamma TK8 lot 146051	Before gamma TK8 lot 148048	After gamma TK8 lot 146051	After gamma TK8 lot 148048
Dart impact (g)	1260	>1300	1100	1150

B6.1.5. Tear Resistance

	Before gamma TK8 lot 146051	Before gamma TK8 lot 148048	After gamma TK8 lot 146051	After gamma TK8 lot 148048
Tear resistance				
Avg force (N) - MD	31	33	17	21
Avg force (N) - TD	45	33	32	29
Initial max load (N) - MD	33	35	18	23
Initial max load (N) - TD	52	38	32	35

Commentary

The tear resistance is expressed in average force and initial max load to tear the film. The measurement is carried out in machine direction (MD) and transverse machine direction (TD).

B6.2. Physical testing

B6.2.1. O₂ Transmission Rate

Item	Norm	Before gamma TK8 lot 146051	After gamma TK8 lot 146051
O ₂ transmission rate	ASTM D3985 (23 °C, 90% RH inside, 50% RH outside)	0.37 cc/m ² .day	0.52 cc/m ² .day

B6.2.2. CO₂ Transmission Rate

Item	Norm	Before gamma TK8 lot 146051	After gamma TK8 lot 146051
CO ₂ transmission rate	ASTM F-2476 (23 °C, 0% RV)	< 1 cc/m ² .day	< 1 cc/m ² .day

B6.2.3. Water Vapor Transmission Rate

Item	Norm	Before gamma TK8 lot 146051	After gamma TK8 lot 146051
Water vapor transmission rate	ASTM F1249 (23 °C, 100% RH inside, 0% RH outside)	0.41 g/m ² .day	0.40 g/m ² .day

B6.3. Chemical and Biological Testing

B6.3.1. Bacterial endotoxin USP <85>

Item	Norm	TK8 lot 148048
Bacterial endotoxin	USP <85>	< 0.005 EU/mL

B6.3.2. Biological reactivity – *in vitro* – ISO 10993-5 and USP <87>

Item	Norm	TK8 lot 148048 after gamma
Biological reactivity	USP <87>	PASS
<i>in vitro</i>	ISO 10993-5	PASS

B6.3.3. Biological reactivity – *in vivo* - ISO 10993-11, ISO 10993-10, ISO 10993-6 and USP <88>

Item	Norm	TK8 lot 148048 after gamma
Biological reactivity	USP <88>	PASS
<i>in vivo</i>	ISO 10993-11	PASS
	ISO 10993-10	PASS
	ISO 10993-6	PASS

B6.4. Physicochemical Test Results

B6.4.1. Tests on plastic materials and components used to package medical articles USP <661>

Item	Norm	TK8 lot 148048 after gamma
Test on plastic materials and components used to package medical articles	USP <661>	PASS

B6.4.2. Tests on plastic containers for aqueous solutions for parenteral infusion EP 3.2.2.1

Item	Norm	TK8 lot 148048 after gamma
Test on plastic containers for aqueous solutions for parenteral infusion	EP 3.2.2.1	PASS

B6.4.3. Tests on polyethylene with additives for containers for parenteral preparations and for ophthalmic preparations EP 3.1.5

The European Pharmacopoeia chapter 3.1.5 refers to “Polyethylene with additives for containers for parenteral preparations and for ophthalmic preparations”. Since the Allegro TK8 film is a laminate containing different non PE resin types, this test is not applicable for this film. We were therefore advised by the test lab not to perform this test on the entire film.

However, the BR4 contact layer of the Allegro TK8 film is a polyethylene film. This film was tested for compliance with EP 3.1.5 section “tests”. All tests passed except for the “substances soluble in hexane”. The reason why it did not pass this test was the low crystallinity of the resin. We repeated this particular test (substances soluble in hexane) on the entire Allegro TK8 film. This test passed the evaluation criteria.

B6.5. Functional testing

B6.5.1 Accelerated ageing tests

The purpose of the accelerated ageing study is to prove a shelf life of 5 years on Allegro TK8 film and biocontainers for film properties and weld properties. To mimic normal use conditions, the first 3 years (will be non-gamma irradiated), the last 2 years (finished good shelf life) will be worst case gamma irradiated (min 50 kGy).

The accelerated ageing time was calculated on the basis of the Arrhenius reaction rate function.

Accelerated ageing time = Real life time/AAF

AAF= Accelerated ageing factor= 11.3 following ASTM F1980-02 (if stored at 55 °C and ambient temperature = 20 °C).

This means that 1 year at 20 °C is equivalent to 32.3 days at 55 °C.

B6.5.1.1 Accelerated ageing tests on film properties

For film properties the following batches are tested:

187062

193149

After 3 years of accelerated ageing the film was gamma irradiated (min 50 kGy) and aged for 2 years till a total of 5 years.

Results are listed in tables on the following pages.

Results lot 187062 for mechanical tests on film

Properties	Spec	t ₀	1 yr	2 yrs	3 yrs	3 yrs γ	4 yrs γ	5 yrs γ	Conclusion
Tensile strength and elongation									
Tensile strength at break MD	Min 19 MPa	35	35	34	34	35	35	32	Conform
Tensile strength at break TD	Min 19 MPa	34	35	35	36	35	37	37	Conform
Elongation at break MD	Min 65%	145	237	208	154	144	126	124	Conform
Elongation at break TD	Min 20%	109	195	160	126	114	107	117	Conform
Young modulus MD	Min 330 MPa	844	752	556	549	647	697	559	Conform
Young modulus TD	Min 330 MPa	1020	734	572	475	574	643	638	Conform
Puncture resistance									
Max load	Min 115 MPa	128	131	128	132	129	123	130	Conform
Deflection at max load	Min 7 mm	10	10	9	10	10	8	8	Conform
Dart impact	700 g	987	900	923	907	962	1002	857	Conform
Flex crack resistance									
500 cycles	<2 pinholes	0.3	0	0	0	0	0	0	Conform
1000 cycles	<4 pinholes	0	0	0.3	0.3	0	0	0	Conform
5000 cycles	<15 pinholes	10.7	5	6	12.3	9	7	7.3	Conform
Tear resistance									
Average force MD	Min 3 N	22	17	18	20	16	18	15	Conform
Average force TD	Min 12 N	28	30	30	31	29	27	30	Conform
Initial max force MD	Min 3 N	21	17	18	19	16	18	15	Conform
Initial max force TD	Min 12 N	30	29	32	32	29	28	31	Conform

Results lot 193149 for mechanical tests on film

Properties	Spec	t ₀	1 yr	2 yrs	3 yrs	3 yrs γ	4 yrs γ	5 yrs γ	Conclusion
Tensile strength and elongation									
Tensile strength at break MD	Min 19 MPa	34	34	34	36	33	36	32	Conform
Tensile strength at break TD	Min 19 MPa	37	37	35	35	36	38	39	Conform
Elongation at break MD	Min 65%	198	138	139	140	115	136	103	Conform
Elongation at break TD	Min 20%	177	105	108	103	104	120	99	Conform
Young modulus MD	Min 330 MPa	540	931	463	499	567	681	678	Conform
Young modulus TD	Min 330 MPA	463	932	464	493	596	624	630	Conform
Puncture resistance									
Max load	Min 115 MPa	134	123	133	129	126	131	127	Conform
Deflection at max load	Min 7 mm	10	9	9	9	9	8	8	Conform
Dart impact	700 g	973	908	1007	1032	992	1002	995	Conform
Flex crack resistance									
500 cycles	<2 pinholes	0.3	0	0	0	0.3	0	0	Conform
1000 cycles	<4 pinholes	0.3	0.3	0.3	0	0.3	0.3	0.3	Conform
5000 cycles	<15 pinholes	3	8.3	6.7	6	6.3	7.3	5	Conform
Tear resistance									
Average force MD	Min 3 N	27	25	25	24	13	14	13	Conform
Average force TD	Min 12 N	37	44	39	38	31	22	18	Conform
Initial max force MD	Min 3 N	30	29	26	28	14	17	15	Conform
Initial max force TD	Min 12 N	43	47	44	38	33	26	23	Conform

Results for gas transmission properties of both lots at the end of the shelf life compared to initial values.

Item	Norm	lot 146051** T ₀ 50 kGy g	Lot 187062 End of shelf life	Lot 193145 End of shelf life
O ₂ transmission rate	ASTM D3985 (23 °C, 90% RH inside, 50% RH outside)	0.52 cc/m ² .day	0.31 cc/m ² .day	0.40 cc/m ² .day
CO ₂ transmission rate	ASTM F-2476 (23 °C, 0% RH)	<1 cc/m ² .day	0.95* cc/m ² .day	1.20* cc/m ² .day
WVTR	ASTM F-1249 (23 °C, 100% RH inside, 0% RH outside)	0.40 g/m ² .day	0.43 g/m ² .day	0.42 g/m ² .day

*The lower detection limit of this test is 1 cc/m².day. The measured values fluctuate because the CO₂ TR is in the region of the lowest limit. The given value is the average of 20 sequential measurements.

**This lot is used for the initial Allegro TK8 film validation. The values given here are for new film that was worst case gamma irradiated.

B6.5.1.2 Accelerated ageing tests on weld properties

The following batches of Allegro TK8 bodies are selected for the study.

Lot 3639089: Body, TK8, N-biocontainer, 25 L

Lot 3628676: Body, TK8, LM-biocontainer, 50 L

The Allegro TK8 bodies are aged accelerated in an incubator at 55 °C. After an equivalent of 3 years for the film, the following batches of Allegro TK8 biocontainers are made from the selected bodies:

Lot 3729587: 25 L biocontainers started from body lot 3639089

Lot 3729588: 50 L biocontainers started from body lot 3628676

These biocontainers are sent for gamma irradiation at 50 kGy (worst case condition) and afterwards stored again in the incubator at 55 °C for 2 more years.

The biocontainers made for this study are engineered with several liquid and powder fitments welded.

Results after biocontainer production lot 3729587

At each time point, 2 biocontainers are tested

Analysis	Spec	3 years non gamma	3 years gamma	4 years gamma	5 years gamma	Conclusion
Integrity test	Pass	Pass	Pass	Pass	Pass	Conform
Seal strength body(1)	Min 45 N/15 mm	Min 90 Av 111	Min 79 Av 103.78	Min 90 Av 100.48	Min 97 Av 105.19	Conform
Seal strength 90° weld(2)	Min 45 N/15 mm	Min 72 Av 94.77	Min 74 Av 96.52	Min 81 Av 97.02	Min 87 Av 99.92	Conform
Seal strength closure weld(3)	Min 45 N/15 mm	Min 78 Av 100.67	Min 98 Av 104.47	Min 92 Av 98.61	Min 101 Av 101.61	Conform
CpK all TK8-TK8 welds	?	1.25	1.62	3.54	4.30	?
Seal strength liquid fitments(4)	Min 25 N/15 mm	Min 91 Av 109.27 CpK 1.79	Min 83 Av 109.36 CpK 2.71	Min 64 Av 94.81 CpK 1.68	Min 54 Av 98.61 CpK 1.53	Conform
Seal strength powder fitments(5)	Min 40 N/15 mm	Min 79 Av 103.17 CpK 1.68	Min 90 Av 104.35 CpK 2.42	Min 85 Av 101.14 CpK 2.65	Min 84 Av 102.95 CpK 2.45	Conform

Min: minimum measurement; Av: average

(1) Per biocontainer, each body weld is tested at 4 positions

(2) Per biocontainer the 2 90° welds are tested at 12 positions

(3) Per biocontainer, the 2 closure welds are tested at 2 positions

(4) Per biocontainer, 3 fitments are tested at 2 positions

(5) Per biocontainer, 3 fitments are tested at 3 positions

Results after biocontainer production lot 3729587

At each time point, 2 biocontainers are tested

Analysis	Spec	3 years non gamma	3 years gamma	4 years gamma	5 years gamma	Conclusion
Integrity test	Pass	Pass	Pass	Pass	Pass	Conform
Seal strength body(1)	Min 45 N/15 mm	Min 89 Av 120.99	Min 89 Av 114.21	Min 89 Av 103.58	Min 100 Av 108.68	Conform
Seal strength 90° weld(2)	Min 45 N/15 mm	Min 73 Av 100.91	Min 86 Av 106.28	Min 77 Av 98.88	Min 83 Av 102.89	Conform
Seal strength closure weld(3)	Min 45 N/15 mm	Min 90 Av 107.37	Min 103 Av 106.83	Min 88 Av 93.80	Min 92 Av 97.39	Conform
Seal strength liquid fitments(4)	Min 25 N/15 mm	Min 66 Av 104.81 CpK 1.37	Min 89 Av 109.12 CpK 2.90	Min 90 Av 106.16 CpK 3.44	Min 81 Av 104.35 CpK 2.16	Conform
Seal strength powder fitments(5)	Min 40 N/15 mm	Min 87 Av 113.33 CpK 1.51	Min 89 Av 103.07 CpK 2.42	Min 88 Av 104.64 CpK 2.86	Min 83 Av 103.40 CpK 1.92	Conform

Min: minimum measurement; Av: average

(1) Per biocontainer, each bodyweld is tested at 4 positions

(2) Per biocontainer the 2 90° welds are tested at 12 positions

(3) Per biocontainer, the 2 closure welds are tested at 2 positions

(4) Per biocontainer, 3 fitments are tested at 2 positions

(5) Per biocontainer, 3 fitments are tested at 3 positions

B6.5.2 Sterilization validation

Our mixing and storage biocontainers are sterile after being irradiated at minimum 25 kGy.

Pall Life Sciences has validated the product according to the Vdmax25 method (ISO11137).

A validation study was performed on our worst case Allegro TK8 product.

The validation study exits out of the following topics;

- Determination of the bioburden with a validated bioburden method according to ISO11737-1.
- Acceptance of the dose verification experiment.
- Acceptance of the sterility tests with a validated sterility test method according to ISO11737-2.
- Acceptance of sterility assurance level of 10^{-6} with a minimum irradiation dose of 25 kGy.
- A triple dose mapping study confirming that a minimum of 25 kGy was reached and not exceeding a maximum of 50 kGy.
- Quarterly execution of the dose audits.

B6.5.3 Freezing study

Preliminary studies have been performed on Allegro 2D biocontainers made of TK8 film to withstand freezing up to -70 °C.

Tests have been done to proof that 2D biocontainers withstand low storage temperatures. Fifteen 2D biocontainers designed with Allegro TK8 film were stored at -70 °C during 2 weeks. After which a series of tests have been performed.

Biocontainers have been tested with:

- C-flex tubing
- Platinum Cured Silicon tubing

The following tests have been performed:

- Visual control
- Integrity by pressure decay
- Drop test (Bayer method and ASTM D5487)
- Mechanical properties:
 - Dimensions
 - Frozen tubing robustness
 - Frozen film folding

Test results:

- Visual control:

After freezing: The biocontainers and the associated tubing maintain integrity with no damage occurring after the freezing process.

After thawing: On every sample, some wrinkles are present on the welding. This failure is due to the external layer of the film which is starting to leave the other layers, it is called delamination. Therefore we performed a leak test to challenge the integrity of the biocontainers. The biocontainers have passed the test, so the content is still safe.
- Integrity by pressure decay:

After freezing, twisting, and folding the samples do not present obvious damages. After thawing, even though some traces of a starting delamination are noticed, the biocontainers passed the drop test and the leak test. So, during their lifecycle and after use, the biocontainers are still integral.
- Drop test:

When the frozen biocontainers reach the ground, the film is between two very hard materials: the ground and the ice. The impact is so strong that even if the film is not brittle, it cannot resist to the shock. Besides this, during the freezing phase, sometimes some pointed shapes are created in the ice and they encourage failure when there is an impact. This test reveals that only one impact can break the biocontainer.
- Dimensions:

No big variation in dimensions is noticed, the dimensions of the biocontainers are stable during their lifecycle.
- Frozen film folding:

The frozen biocontainers are still soft and easy to fold. No white marks appeared on the biocontainers after folding and the film is not brittle. After thawing every biocontainer has passed the leak test. So the biocontainers remain their mechanical properties after thawing and still protect their content.
- Frozen tubing robustness:

By twisting the tubing, we didn't feel any difference between the tubes with ice and the tube without ice. Although the ice does not make the twisting easy, the tubes material remained soft and easy to manipulate. No brittle failure occurred during the test.

Conclusion

The freezing process does not make the film and the tubing more brittle. Indeed, after twisting them and folding them, they are not damaged. The biocontainers are soft and can be manipulated safely in normal conditions.

Nevertheless, the biocontainers cannot withstand any drops even though the height is low. That's why we advise to protect them with a shell, designed in a stronger material.

After thawing, even though some traces of a starting delamination are noticed, the biocontainers regain their mechanical properties and passed the drop and leak tests. So, after thawing the integrity of the biocontainer is good.

C. Extractables and leachables data of the Allegro TK8 film

In order to appreciate the report's findings, it is important to understand the distinction between the terms "extractables" and "leachables". There is now a general consensus among the industry and regulatory agencies on the following definitions:

Extractables: Chemical compounds that migrate from elastomeric, plastic or coating components when exposed to an appropriate solvent under exaggerated conditions of time and temperature.

Leachables: Chemical compounds, typically a subset of extractables, that migrate from elastomeric, plastic or coating components as a result of direct contact with the drug formulation under normal process conditions or accelerated storage.

Each extractables and leachables study is performed in a specifically designed sample biocontainer of 1 L made out of Allegro TK8 film, to maximize the fluid contact ratio and with the easy-drain and standard tubing and connectors in contact with the test solution.



Pall Life Sciences' 1 L sample biocontainer for E/L studies, allowing contact with the Allegro TK8 film, the easy-drain valve, the standard tubing and the connector.

C1. Extractables study

C1.1. Introduction

Polymers, used in the production of pharmaceutical containers and medical devices, cannot be considered as pure compounds. Medical grade polymers should be seen as a blend of the base polymers with a broad range of chemicals that may be added for several reasons.

Polymer additives are added to improve the process ability of the polymer or to enhance its end-use performance in various ways. Moreover, residues of unexpected and undesirable compounds may also be present and can affect the biocompatibility and the toxicity of the materials. Residues may originate from unreacted monomers, solvents used in the process, polymerization catalyst, surfactants, or polymer degradation products.

The concentration of these chemicals/impurities in the polymer can range from a few µg/kg to the percentage level and their migration behavior is often not known or is considered as proprietary information by the supplier. This makes it very difficult to assess the toxicological potential of products that may migrate out of the polymers during contact with pharmaceuticals.

Both the Pharmaceutical and Medical Industries require - in well defined cases - to assess the toxicological risk associated with the use of the product. The FDA, as well as the EMEA, suggest in these cases to perform an extraction study on pharmaceutical containers or medical devices to determine which chemical species may migrate out of the polymer material and at which concentration level. These data will allow evaluation of the toxicological risk caused by the extracted substances.

C1.2. Study purpose

The aim of this analytical study was to identify polymer additives, impurities, and degradation products present in and on the Pall Film Material 'Allegro TK8 Film, Batch 148048/5'. For this purpose, a sample extract was prepared by refluxing the test article in dichloromethane (DCM). Headspace analysis was performed on a neat sample of the test article.

The samples were subjected to one or more of the following analytical methods:

1. Headspace Gas Chromatography/Mass Spectrometry (HS-GC/MS) to determine volatile organic compounds (VOC);
2. Gas Chromatography/Mass Spectrometry (GC/MS) to determine semi-volatile compounds (SVOC);
3. Liquid Chromatography/Mass Spectrometry (LC/MS) to determine non-volatile organic compounds (e.g. polymer additives).

C1.3. Results of extractables study

The results of this material characterization study may be used to further study the migration of these compounds under simulated use conditions.

Analysis	Compound	Concentration (mg/kg) TK8, lot 148048
Volatile Organic Compounds (neat) Reporting limit: 0.8 µg/g	2-Methyl-1-propene (Isobutylene)	5.9
	Acetaldehyde	5.0
	Methyl formate	3.8
	Ethanol	0.9
	Acetone	2.0
	Methyl acetate	1.6
	2-Methyl-2-propanol	3.4
	Butanal	1.7
	2-butanone (MEK)	1.8
	Acetic acid	11
	Pentanal	0.9
	t-Butyl hydroxyperoxide	1
	Propanoic acid	0.8
	2,2-Dimethyl-propanoic acid	0.8
	1-(acetyloxy)-2-propanone	0.9
	Octamethylcyclotetrasiloxane	1.6
	Isododecane	35
	Unknown 1 : main masses 43, 45, 74, 58, 116	2.2
	Branched alkanes	2.1 + 2.3 + 1.6
	Pentanamide	1.1
Dodecane	1	
Semi-volatile Organic Compounds (DCM) Reporting limit: 5 µg/g	1,3-Di-tert-butylbenzene	26
	Caprolactam	3.6
	Isododecane	30
	1,3-Di-tert-butylbenzene + Caprolactam	140
	2,4-Di-tert-butylphenol	25
	Isophorone diisocyanate	26
	1,8-diazacyclotetradecane-2,9-dione	6
	1-Octacosane	9
	Diglycidyl bisphenol A	100
	1-Triacontane	9
	1-Dotriacontane	6
	Oxidized Irgafos 168	47

Analysis	Compound	Concentration (mg/kg) TK8, lot 148048
Non-Volatile Organic Compounds (DCM)	Oleamide	< 0.7
	Erucamide	< 1
	Irganox 1330	< 0.2
	Irgafos 168	< 0.8
	Irgafos 168ox.	35
	BHT	< 0.4
	Hostanox 03	< 0.8
	Irganox 3114	< 1
	Irganox 1010	{0.6}
	Irganox 1076	1.6
	Irgafos 126	< 0.5
	Irganox 245	< 0.2
	A.O. 2246	{1.5}
	Palmitic acid	50
	Oleic acid	< 5
	Stearic acid	65
	Myristic acid	< 2

Values between brackets: Value between method detection limit and quantification limit, therefore only indicative.

C2. Leachables studies

C2.1. Introduction

In the analytical program followed, the migration behavior of the Pall single use mixing biocontainers made out of Allegro TK8 film 'TK8, Batch 148048/5' was monitored in function of different conditions. This migration study was based on a dynamic analytical approach.

The contact study was performed under following conditions: except for DMSO (see below), storage was carried out at 40±2 °C and 75% humidity.

During the 6 months storage period, 3 different time points were taken to monitor the migration behaviour of several target analytes over the entire migration period:

- t = 1 week
- t = 1 month
- t = 6 months

Seven different solutions were used:

- Water for injection
- Ethanol 20%
- An acid solution, HCl (pH < 3)
- An alkaline solution, NaOH (pH > 11)
- A concentrated salt solution, 1M NaCl
- A solvent, 10% DMSO, tests performed at -20 °C
- A detergent, 0.1% Tween

The migration behavior at every time point was verified and compared with the blank solution, stored in a glass bottle, at the equivalent time points. In this way, it becomes possible to discriminate migration and material degradation compounds from compounds originating from the matrix/solution degradation under accelerated ageing conditions. This approach is also recommended in the ICH guideline Q1D for Bracketing and Matrixing designs for Stability Testing.

C2.2. Study purpose

The purpose of this analytical study program is to carry out an identification of the polymer additives, impurities and degradation products, present in and on the biocontainer.

For the semi-volatile and non-volatile trace compounds or additives, a portion of the contact solution in the biocontainer material is prepared via an exhaustive extraction followed by a semi-quantitative or quantitative analytical determination of the target compounds via GM/MS and LC/MS. GC/MS and LC/MS allow to carry out an identification of the target compounds based on the mass spectrum of the eluting compound and its specific retention time.

The determination of monomers, residual solvents, volatile degradation products and other volatile compounds, present in the contact solution after the contact time, can be determined semi-quantitative using headspace gas chromatography with mass spectral detection. Headspace GC/MS allows to carry out an identification of the target compounds based on the mass spectrum of the eluting compound and its specific retention time.

For the analysis of trace metals, a portion of the biocontainer material is mineralized via a destruction of the polymer, followed by a quantitative analytical determination of the target metals via ICP-AES.

C2.3. Test methods

C2.3.1. pH

Monitoring the pH of the extraction solvent during or after a prolonged contact between the solvent and the device or the material to be tested, can be an indication of the release of any substance that changes the acidic/alkaline properties of an aqueous extract.

C2.3.2. Conductivity

The conductivity is a measure of the ability of an aqueous solution to carry an electric current via the presence of ions. In general, most inorganic compounds dissociate in an aqueous solution to form cations and anions, and are therefore relatively good conductors. Organic compounds, however, do not dissociate in aqueous solutions. As a consequence, organic compounds conduct a current poorly.

An increase in conductivity during a prolonged contact study is an indication that cations and anions are released from the device/material into the extraction solution.

C2.3.3. TOC

A change in total organic carbon or TOC content in the extraction solvent provides more information about the total amount of organic material that migrates from biocontainer material into the extraction solvent. All organic compounds, detected in the subsequent organic analyses like purge- and trap GC/MS, dichloromethane extraction + GC/MS and LC/MS are also detected in the TOC analysis. Therefore, the TOC value can be considered as an organic sum parameter and it can be used to check the mass balance of all individual organic compounds identified and quantified with the advanced organic analyses.

C2.3.4. Metals

A range of polymer additives such as fillers (eg. Talc), pigments and catalyst residues are metal base complexes, or do contain certain metals in their molecular structure. Migration of these polymer additives into the extraction fluid may then be seen via the presence of the corresponding metals in the extraction fluid.

In addition, other polymer processing steps (eg. Washing steps) may introduce other inorganic impurities that may contain metals.

C2.3.5. Volatile organic compounds via purge- and trap GC/MS

Volatile organic molecules which migrate into the contact solution during a prolonged contact step between a medical device or a test material and the extraction solution, may come from various sources like monomer residues, solvent residues from various production steps, residues from polymer treatments (eg. Washing) or smaller polymer breakdown products. The selected technique for this analytical method – Purge and Trap coupled to a Gas Chromatography (or GC) with Mass Spectrometry (or MS) as a detection technique – allows to carry out an identification of the target analytes based on both the retention time of the analytes in the chromatogram and the mass spectrum of the eluting compound at this specific retention time.

For this study, a screening mode is chosen to identify and qualify the migration products as broadly as possible.

The concentration of detected volatile compounds could be estimated by a semi-quantitative internal calibration method. For this purpose, the relative analytical response of a reported compound was compared to the response of an appropriate internal standard toluene-d₈, added to the samples at a fixed concentration.

C2.3.6. Semi-volatile organic compounds via dichloromethane extraction + GC/MS

A lot of potential organic migration products are not volatile enough to detect these compounds via Purge and Trap GC/MS. However, the thermostable compounds are still volatile enough to be studied via GC/MS, even though under different experimental and instrument conditions than used with Purge and Trap GC/MS. These products are called the semi-volatile compounds. These semi-volatile compounds may come from various sources like process lubricants, plasticizers, anti-oxidants, polymer degradation products and solvents with a higher boiling point.

The selected analytical method – Dichloromethane extraction followed by GC with MS as a detection technique – allows to carry out an identification of the target analytes based on both the retention time of the analytes in the chromatogram and the mass spectrum of the eluting compound at this specific retention time.

Specifically for semi-volatile compounds, the concentration of detected semi-volatile compounds could be estimated by a semi-quantitative internal calibration method. For this purpose, the relative analytical response of a reported compound was compared to the response of an appropriate internal standard (2-Fluorobiphenyl, added to the samples at fixed concentration).

In a first step of the total analytical method, the water samples are extracted with an organic solvent with a low boiling point. In general, the solubility of organic compounds is much larger in organic solvents than in water. During the extraction, most organic compounds are concentrated in the organic phase.

C2.3.7. Non-volatile organic compounds via dichloromethane extraction + LC/MS

For migration compounds that are non-volatile or non-thermostable (like anti-oxidants, fillers, plasticizers, polymerization or hydrogenation catalysts, anti-slip agents and other polymer additives), Liquid Chromatography (or LC) is better suited as an analytical tool than GC. Mass spectral detection is selected as a detection technique because it offers numerous advantages over the traditional LC/UV-Vis technique such as additional molecular and structural information of the compounds, a higher sensitivity of the instrument and a better identification of the target compounds. In addition, the instrument can also be run in a second order MS mode (or MS-MS) when complex matrices are to be analyzed.

The analytes present in the extract are identified from their retention time and the corresponding mass spectrum in a quantitative manner.

In a first step of the total analytical method, the water samples are extracted with an organic solvent with a low boiling point. In general, the solubility of organic compounds is much larger in organic solvents than in water. During the extraction, most organic compounds are concentrated in the organic phase.

Remark: Due to the foam forming tendency of Tween, the method was adapted. For analysis involving this detergent, dichloromethane extraction + PTV/GC/MS was applied. For t= 1 week and t= 4 month, a semi-quantitative method was used. For t= 6 months, a quantitative method was used.

C2.4. Evolution of pH with time

No value increase compared to blank and after different contact times

pH Value TK8, lot 148048	1 week blank	1 week	1 month blank	1 month	6 months blank	6 months
WFI	6.15	6.18	5.98	5.64	5.78	5.73
HCl - pH < 3	2.39	2.43	2.58	2.52	2.52	2.43
NaOH - pH >11	11.68	11.71	11.51	11.64	10.34	11.73

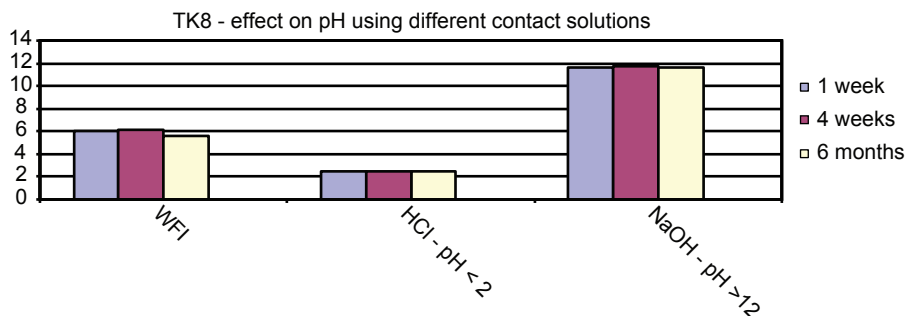

Commentary

Allegro TK8 film has no significant effect on pH.

C2.5. Evolution of Conductivity with Time

Conductivity TK8, lot 148048	1 week blank	1 week	1 month blank	1 month	6 months blank	6 months
WFI	0.8	0.8	5.9	3	1.6	1.6
HCl - pH < 3	1.8	1.8	1.7	1.9	1.8	1.8
NaOH - pH >11	1.4	1.5	1.3	1.6	0.5	1.5

Unit= $\mu\text{S}/\text{cm}$

Commentary

Allegro TK8 film has no significant effect on conductivity.

Remark: The high value for the blank after 1 month of WFI treatment is the reason for the abnormal value seen for 1 month for WFI.

C2.6. Evolution of TOC with time

TOC TK8, lot 148048	1 week	1 month	6 months
WFI	350	660	1064
NaOH - pH >11	820	970	1730

Unit= $\mu\text{g}/\text{L}$

Value= test item minus blank value

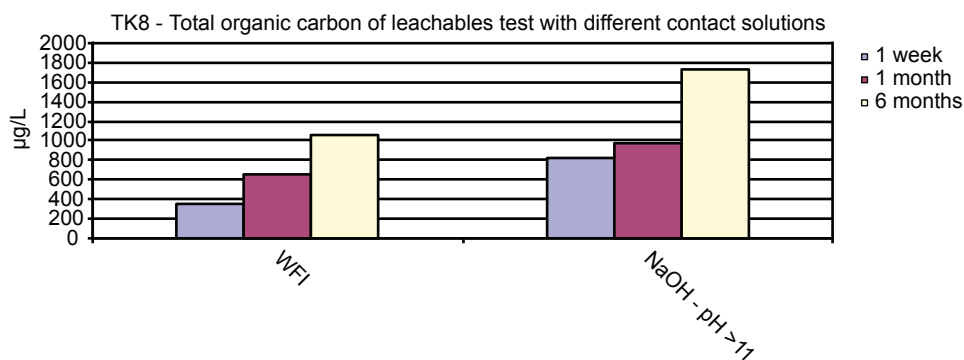

Commentary

Allegro TK8 film has an effect on total organic carbon. The TOC of the contact solutions were increased compared to the blank solutions and increased as well over time.

C2.7. Evolution of metals with time

No metal ions or very low conc <200 ppb traced back

Metal analysis did not show any clear trend for increased concentrations of certain metals in the biocontainer solutions.

Overview of metals, concentration in ppb

TK8, lot 148048		Al	Ba	Ca	K	Li	Mg	Na	Zn
WFI	1 week	nd	nd	nd	nd	nd	nd	nd	nd
	1 month	nd	nd	nd	nd	nd	nd	nd	3
	6 months	nd	1	nd	nd	nd	nd	nd	2
Ethanol 20%	1 week	6	nd	nd	nd	nd	nd	nd	nd
	1 month	nd	nd	nd	40	4	nd	15	2
	6 months	nd	3	nd	nd	nd	nd	nd	2
HCl pH<3	1 week	1	nd	109	10	nd	10	13	2
	1 month	nd	2	1	nd	nd	nd	nd	2
	6 months	nd	nd	nd	10	nd	nd	13	1
NaOH pH>11	1 week	nd	nd	nd	nd	nd	nd	nd	nd
	1 month	nd	nd	nd	nd	nd	nd	nd	nd
	6 months	nd	nd	nd	nd	nd	nd	nd	nd
NaCl 1M	1 week	nd	nd	nd	nd	nd	nd	nd	nd
	1 month	nd	nd	nd	20	nd	nd	nd	nd
	6 months	nd	nd	nd	nd	nd	nd	nd	nd
DMSO 10%	1 week	nd	nd	1	nd	nd	nd	nd	nd
	1 month	nd	1	nd	nd	nd	nd	nd	2
	6 months	nd	nd	nd	nd	nd	nd	nd	nd
Tween 0.1%	1 week	nd	nd	nd	nd	nd	nd	86	nd
	1 month	3	1	3	nd	nd	nd	195	1
	6 months	nd	nd	4	nd	nd	5	86	nd

nd = not detected

Values= Test item minus blank value

C2.8. Evolution of extracted components with time

Very low concentrations of the following extracted components could be identified.

Overview of extracted components, concentration in ppb

TK8, lot 148048		≤ 10 ppb	10 – 100 ppb	100 – 500 ppb
WFI	1 week	Isobutylene 1,3-Di-tert-butylbenzene 2,4-Di-tert-butylphenol	Caprolactam	
	1 month	Isobutylene	Caprolactam + 1,3 - Ditert-butylbenzene 2,4 Di-tert-butylphenol	
	6 months	Trimethyl silanol	Caprolactam + 1,3 Di-tert-butylbenzene 2,4 Di-tert-butylphenol	
Ethanol 20%	1 week		Irganox 1076	Palmitic acid
	1 month			
	6 months		Irganox 1076	Palmitic acid Oleic acid

TK8, lot 148048		≤ 10 ppb	10 – 100 ppb	100 – 500 ppb
HCl pH<3	1 week		Caprolactam 2,4- Di-tert-butylphenol	
	1 month		Caprolactam + 1,3- Di-tert-butylbenzene 2,4- Di-tert-butylphenol	
	6 months	Trimethylsilanol	Caprolactam	
NaOH pH>11	1 week	Isobutylene	Caprolactam 2,4-Di-tert-butylphenol Palmitic acid Stearic acid	
	1 month	Isobutylene Myristic acid	Caprolactam+ 1,3- Di-tert-butylbenzene 2,4-Di-tert-butylphenol Palmitic acid Stearic acid	
	6 months	Isobutylene Trimethylsilanol 2,4-Di-tert-butylphenol	Caprolactam+ 1,3- Di-tert-butylbenzene Myristic acid Unknown compound	Palmitic acid Stearic acid
NaCl 1M	1 week		Caprolactam	
	1 month	Stearic acid Myristic acid	Caprolactam+ 1,3 Di-tert-butylbenzene Palmitic acid	
	6 months		Trimethylsilanol Caprolactam+ 1,3 Di-tert-butylbenzene	
DMSO 10%	1 week		Palmitic acid	Stearic acid
	1 month			
	6 months			
Tween 0.1%	1 week	Isobutylene n-Dodecane Tetradecane	Isododecane Caprolactam 2,4-Di-tert-butylphenol Unknown component	1,3-Di- tertbutylbenzene
	1 month	Isobutylene n-Dodecane Unknown branched alkane	Isododecane Caprolactam Tetradecane 2,4-Di-tertbutylphenol	1,3-Di-tert- butylbenzene Isododecane
	6 months	Isobutylene Trimethylsilanol Tetradecane	Isododecane n-Dodecane Unknown branched alkane Tetradecane 2,4-Di-tert-butylphenol	1,3-Di-tert- butylbenzene

DMSO = Dimethyl Sulfoxide
Values= test item minus blank value

C2.9. General Conclusion of leachables studies

- There is no significant effect on pH and conductivity.
- Allegro TK8 film has an effect on total organic carbon. The TOC contents of the contact solutions were increased compared to the blank solutions and increased as well over time.
- Only very low metal concentrations could be detected in the test solutions.
 - Main elements Ca, Na, K – max 200 ppb
 - If other elements present, max 10 ppb
- Very low concentrations of the following extracted components could be identified;
 - Caprolactam; nylon 6 monomer
 - 2,4-Di-tert-butylphenol and 1-3-Di-tert-butylbenzene are known degradation products of aromatic anti-oxidants. The degradation products can be formed when the thermo-oxidative degradation of the polymer is inhibited by the desired function of the additives to prevent oxidation.
 - Fatty acids; organic acids as degradation products during auto-oxidation of polymer
 - Tetradecane, n-Dodecane, Isododecane, Isobutylene: Oligomers to be found as residues in polymers. However, their presence could also be related to polymer degradation after sterilization by gamma irradiation.
 - Irganox 1076; polymer additive.
 - Trimethylsilanol: Originates from the tubing

C2.10. Summary of results

TK8 Lot 148048 rol 5

Contact area test biocontainer	620 cm ² , incl drain
Volume in test biocontainer	1100 mL
Surface/volume	0.56 cm ² /mL
Temperature	40 °C

WFI as contact liquid	1 week	1 month	6 months
pH	6.18	5.64	5.73
Conductivity (µS/cm)	0.8	3	1.6
TOC - blank subtracted (µg/L)	350	660	1064
Metals via ICP analysis (µg/L or ppb)			
Zn		3	2
Ba			1
Headspace + GC/MS (µg/L) - volatile components			
2-Methyl-1-propene (isobutylene)	7	8	
1,3 Di-tert-butylbenzene	5		
Trimethylsilanol			8
Dichloromethane extraction + GC/MS (µg/L)- semi-volatile components			
Caprolactam (+1,3-Di-tert-butylbenzene)	15	27	47
2,4-Di-tert-butylphenol	6	12	14
Dichloromethane extraction + LC/MS (µg/L) - non-volatile components			

Metals, TOC, HS-GC/MS, GC/MS, LC/MS : Test item minus blank value
Empty field= not detected

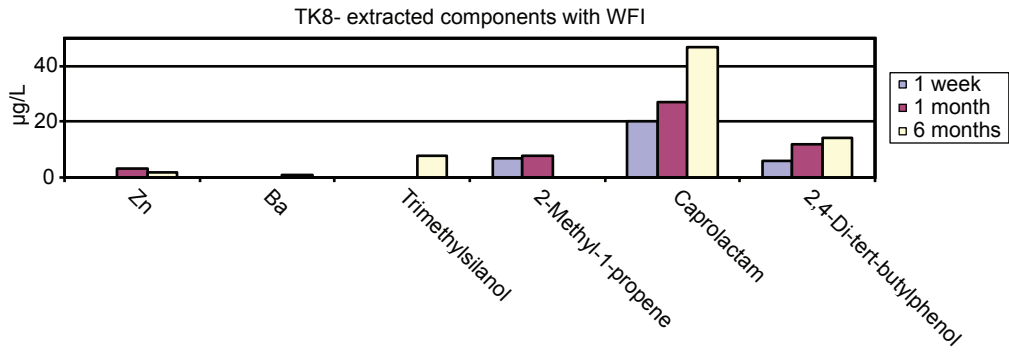

TK8 Lot 148048 rol 5

Contact area test biocontainer 620 cm², incl drain
 Volume in test biocontainer 1100 mL
 Surface/volume 0.56 cm²/mL
 Temperature 40 °C

Ethanol 20% as contact liquid	1 week	1 month	6 months
Metals via ICP analysis (µg/L or ppb)			
Al	6		
K		40	
Li		4	
Na		15	
Zn		2	2
Ba			3
Headspace + GC/MS (µg/L) - volatile components			
Dichloromethane extraction + GC/MS (µg/L) - semi-volatile components			
Dichloromethane extraction + LC/MS (µg/L)- non-volatile components			
Irganox 1076	70*		40*
Palmitic acid	1000*		1000
Oleic acid			800*

Metals, TOC, HS-GC/MS, GC/MS, LC/MS : Test item minus blank value

* result above detection limit but below quantification limit

Empty field= not detected

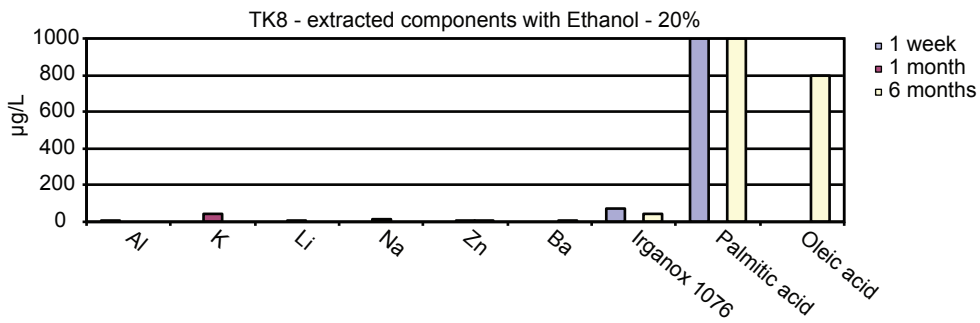

TK8 Lot 148048 rol 5

Contact area test biocontainer 620 cm², incl drain
 Volume in test biocontainer 1100 mL
 Surface/volume 0.56 cm²/mL
 Temperature 40 °C

HCl - pH < 3 as contact liquid	1 week	1 month	6 months
pH	2.43	2.52	2.43
Conductivity (µS/cm)	1.8	1.9	1.8
Metals via ICP analysis (µg /L)			
Al	1		
Ca	109	1	
K	10		10
Mg	10		
Na	13		13
Zn	2	2	1
Ba		2	
Headspace + GC/MS (µg/L) - volatile components			
Trimethylsilanol			8
Dichloromethane extraction + GC/MS (µg/L) - semi-volatile components			
Caprolactam (+1,3-Di-tert-butylbenzene)	27	29	15
2,4-Di-tert-butylphenol	13	12	
Dichloromethane extraction + LC/MS (µg/L) - non-volatile			

Metals, TOC, HS-GC/MS, GC/MS, LC/MS : Test item minus blank value
 Empty field= not detected

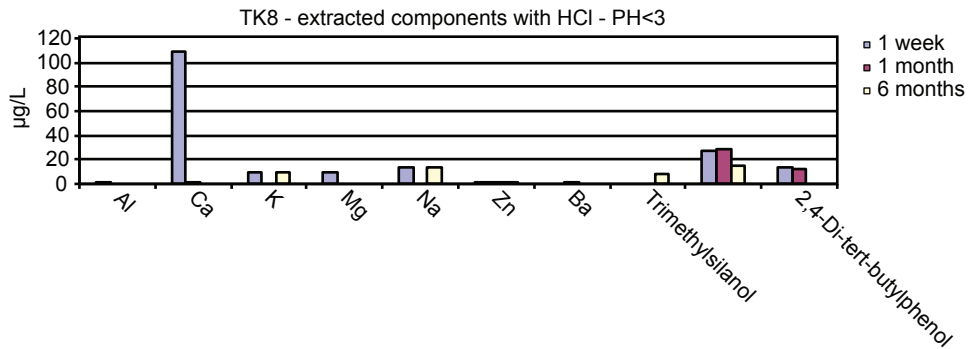

TK8 Lot 148048 rol 5

Contact area test biocontainer 620 cm², incl drain
 Volume in test biocontainer 1100 mL
 Surface/volume 0.56 cm²/mL
 Temperature 40 °C

NaOH - pH >11 as contact liquid	1 week	1 month	6 months
pH	11.71	11.64	11.73
Conductivity (µS/cm)	1.5	1.6	1.5
TOC (µg /L)	820	970	1730
Metals via ICP analysis (µg/L or ppb)			
Headspace + GC/MS (µg/L) - volatile components			
2-Methyl-1propene (Isobutylene)	7	8	5
Trimethylsilanol			6
Dichloromethane extraction + GC/MS (µg/L) - semi-volatile components			
Caprolactam (+ 1,3 Di-tert butylbenzene)	24	15	15
2,4-Di-tert-butylphenol	25	14	9
Palmitic acid			8
Unknown compound (main masses: 126, 57, 41, 69, 167,210)			25
Dichloromethane extraction + LC/MS (µg/L)- non-volatile components			
Palmitic acid	60	44	166
Stearic Acid	60*	30	130
Myristic acid		2*	20

Metals, TOC, HS-GC/MS, GC/MS, LC/MS : Test item minus blank value

* result above detection limit but below quantification limit

Empty field= not detected

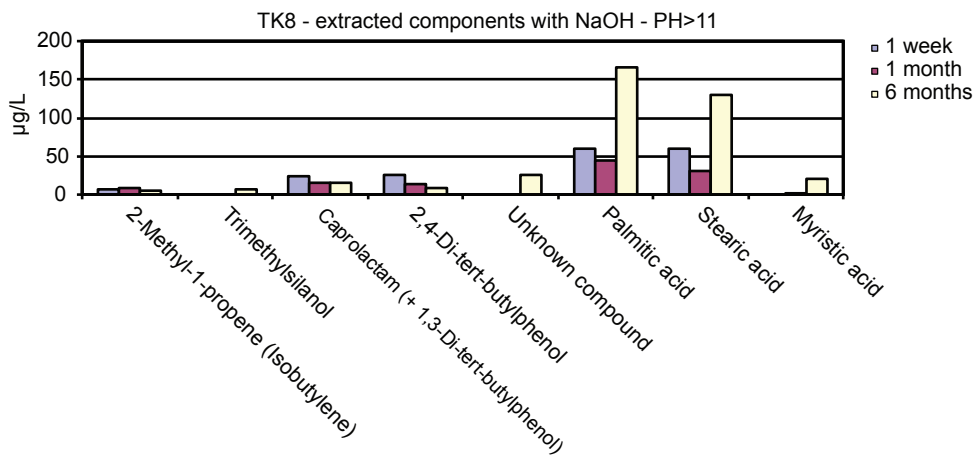

TK8 Lot 148048 rol 5

Contact area test biocontainer 620 cm², incl drain
 Volume in test biocontainer 1100 mL
 Surface/volume 0.56 cm²/mL
 Temperature 40 °C

NaCl 1M as contact liquid	1 week	1 month	6 months
Metals via ICP analysis (µg/L or ppb)			
K		20	
Headspace + GC/MS (µg/L) - volatile components			
Trimethylsilanol			11
Dichloromethane extraction + GC/MS (µg/L) - semi-volatile components			
Caprolactam (+ 1,3 Di-tert butylbenzene)	25	29	56
Dichloromethane extraction + LC/MS (µg/L) - non-volatile components			
Palmitic acid		10	
Stearic Acid		8*	
Myristic acid		2*	

Metals, TOC, HS-GC/MS, GC/MS, LC/MS : Test item minus blank value

* result above detection limit but below quantification limit

Empty field= not detected

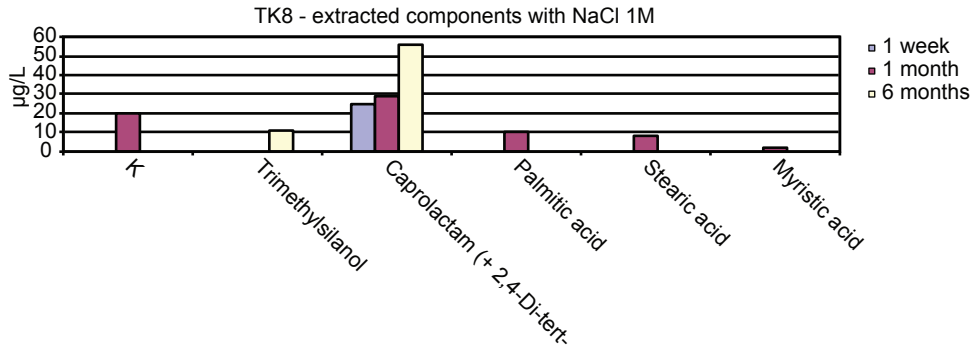

TK8 Lot 148048 rol 5

Contact area test biocontainer 620 cm², incl drain
 Volume in test biocontainer 1100 mL
 Surface/volume 0.56 cm²/mL
 Temperature -20 °C

DMSO 10% as contact liquid	1 week	1 month	6 months
Metals via ICP analysis (µg/L or ppb)			
Ca	1*		
Ba		1*	
Zn		2*	
Headspace + GC/MS (µg/L) - volatile components			
Dichloromethane extraction + GC/MS (µg/L) - semi-volatile components			
Dichloromethane extraction + LC/MS (µg/L)- non-volatile components			
Palmitic acid	70*		
Stearic Acid	130*		

Metals, TOC, HS-GC/MS, GC/MS, LC/MS : Test item minus blank value
 * result above detection limit but below quantification limit
 Empty field= not detected

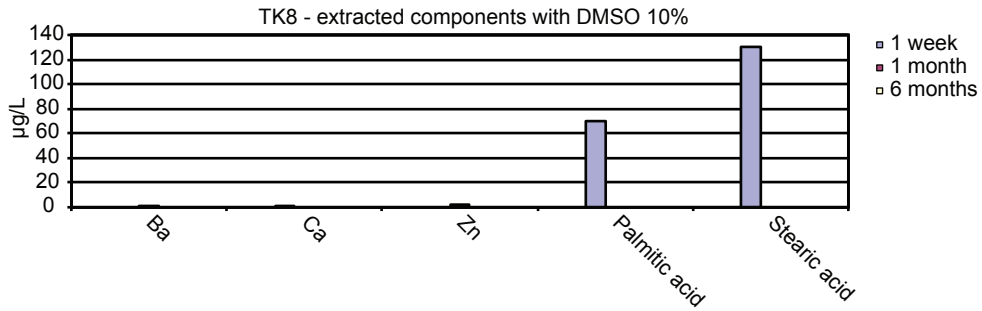

TK8 Lot 148048 rol 5

Contact area test biocontainer 620 cm², incl drain
 Volume in test biocontainer 1100 mL
 Surface/volume 0.56 cm²/mL
 Temperature 40 °C

Tween 0.1% as contact liquid	1 week	1 month	6 months
Metals via ICP analysis (µg/L or ppb)			
Na	86	195	86
Al		3*	
Ba		1	
Ca		3	4*
Zn		1*	
Mg			5*
Headspace + GC/MS (µg/L) - volatile components			
2-Methyl-1-propene (Isobutylene)	6	6	7
2,2,4,6,6-Pentamethylheptane (Isododecane)	92	100	66
Unknown branched alkane		5	
n-Dodecane	6	8	12
Tetradecane			7
1,3-Di-tert-butylbenzene	100	100	96
Trimethylsilanol			6
Dichloromethane extraction + GC/MS (µg/L) - semi-volatile components			
Caprolactam	22	15	
1,3-Di-tert-butylbenzene	106	130	102
2,4-Di-tert-butylphenol	41	13	37
2,2,4,6,6-Pentamethylheptane (Isododecane)	23	37	
Tetradecane	8	16	23
Unknown branched alkane			73
Unknown component (main masses 57, 190, 283, 339, 395, 410)	24		
Dichloromethane extraction + PTV/GC/MS (µg/L)- non-volatile components			

Metals, TOC, HS-GC/MS, GC/MS, LC/MS : Test item minus blank value

* result above detection limit but below quantification limit

Empty field= not detected

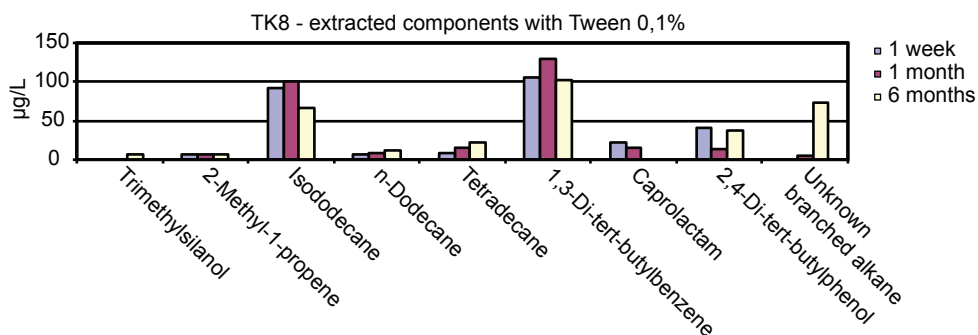
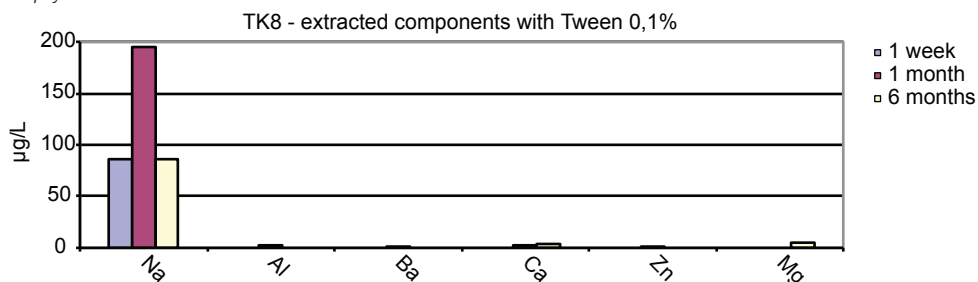

C2.11. Leachables Study Full Results

C2.11.1. Test solution WFI

Full report is available on request. Please contact Pall at allegro@pall.com.

C2.11.2. Test solution Ethanol 20%

Full report is available on request. Please contact Pall at allegro@pall.com.

C2.11.3. Test solution HCl

Full report is available on request. Please contact Pall at allegro@pall.com.

C2.11.4. Test solution NaOH

Full report is available on request. Please contact Pall at allegro@pall.com.

C2.11.5. Test solution NaCl

Full report is available on request. Please contact Pall at allegro@pall.com.

C2.11.6. Test solution DMSO 10%

Full report is available on request. Please contact Pall at allegro@pall.com.

C2.11.7. Test solution Tween 0.1%

Full report is available on request. Please contact Pall at allegro@pall.com.

D. Chemical compatibility test

D1. Study purpose

The Allegro TK8 film was exposed to defined solutions according to ASTM D543-06: Standard Practices for Evaluation of the resistance of Plastics to Chemicals. Check Allegro TK8 film compatibility/resistance after contact with a number of selected solutions.

D2. Test methods

- A test protocol was set-up by Pall based on ASTM D543-06. Spec properties were fixed in advance based on Allegro TK8 film data after gamma sterilization.
- Following blank samples were included
 - Reference Allegro TK8 1 L biocontainer after gamma treatment
 - Empty Allegro TK8 biocontainers stored at 3 test temperatures
 - Allegro TK8 biocontainers filled with WFI and stored at 3 test temperatures
- For each solution and temperature, 4 sample biocontainers were used: 3 biocontainers for thickness, weight, dimensions, mechanical tests, microscopy, IR and 1 biocontainer for leakage test.
- IR spectra and microscopy pictures of drain and PE contact layer were obtained and compared to the references.
- The film resistance to the test solutions was evaluated on the basis of the property specs, the blank data and the ranking of the various test properties.

D3. Test solutions

	Product	Conc.	Temp	Contact time
1	Acetic acid	100 g/L	60 °C	3 hours
2	NaOH 50%	200 g/L (5M)	60 °C	3 hours
3	MgSO ₄ .7H ₂ O	100 g/L	30 °C	7 days
4	MnSO ₄ .7H ₂ O	100 g/L	30 °C	7 days
5	KH ₂ PO ₄	136 g/L (1M)	30 °C	7 days
6	Ethanol 55%	550 mL/L	30 °C	7 days
7	Bleach (NaClO) 15° + NaOH 0.5M	50/50 (v/v)	50 °C	3 hours
8	Riboflavine (vit B2)	10 g/L	30 °C	7 days
9	Kanamycine sulfate	100 g/L	30 °C	7 days
10	Caseine hydrolysate	30 g/L	30 °C	7 days
11	TRIS : Tromethanine (HOCH ₂) ₃ CNO ₂	100 g/L	30 °C	7 days
12	Diethanolamine (DEA/Ureum/SLS)	5 g/L + Ureum 8M + SLS1%	30 °C	7 days
13	Guanidine HCl	800 g/L	30 °C	7 days
14	Yeast extract	50 g/L	30 °C	7 days

D4. Results of the chemical compatibility tests

- The results are summarized in the following tables
- A ranking is given for each of the properties
1 = highest priority
- The appearance of the film and drain will be commented by means of a number; 1 = no change, 2 = surface defects, 3 = complete surface dissolving or attacked
- The IR spectrum of the film and the drain will be commented by means of a matching number from the QC compare test with the placebo sample
- The chemical compatibility is concluded as:
Resistant (+) = specs in table are obtained
Limited resistance (/) = data decreased < 50% vs spec
No resistance (-) = data decrease > 50% vs spec

7 days – 30 °C

Properties	Units	Ranking	Blanco		MgSO ₄ .7H ₂ O	MnSO ₄ .7H ₂ O	KH ₂ PO ₄	KH ₂ PO ₄	Ethanol 55%	Riboflavin (vit B2)		Caseine hydrolysate	Tromethamine (TRIS)		Diethanolamine	Guanidine HCl		Yeast extract	Spec (after 50 KG gamma)	
			Blanco	WFI						Ribo	Kana sulfate		TRIS	Dietha		Guan	Yeast			
Solvent nr	N/15 mm	1	BL-30	WFI-30	MgSO ₄	MnSO ₄	KH ₂ PO ₄	KH ₂ PO ₄	Ethanol	Ribo	Kana	Caseine	TRIS	Dietha	Guan	Yeast				
Seal strength Film to film	mm	1	100 (19)	109 (14)	95 (7)	103 (18)	101 (14)	98 (9,9)	104 (9)	95 (16)	88 (5)	97 (13)	101 (10)	90 (17)	94 (21)	> 60				
Seal width Film to film	mm	1	5 (0)	5 (0)	5 (0)	5 (0)	5 (0)	5 (0)	5 (0)	5 (0)	5 (0)	5 (0)	5 (0)	5 (0)	5 (0)	5 +/- 1mm				
Film strength MD	N/15 mm	1	28 (1,7)	26 (4,3)	27 (3,3)	27 (0,9)	27 (1,5)	28 (1,1)	27 (1,2)	28 (3,1)	26 (4)	28 (3,4)	29 (1,5)	31 (3,0)	28 (1,3)	> 19				
TD	%	2	31 (3,9)	31 (3,4)	31 (2,3)	31 (1,9)	30 (1,9)	28 (3,7)	33 (3,2)	32 (4,3)	32 (4,7)	30 (5,5)	29 (4,1)	30 (4,2)	30 (3,2)					
Elongation MD	%	2	100 (22)	88 (42)	92 (22)	98 (24)	90 (20)	101 (1,4)	85 (15)	92 (34)	85 (36)	89 (42)	119 (8,4)	112 (13)	90 (29)	> 65				
TD	mbar	1	67 (17)	85 (19)	84 (21)	85 (19)	80 (16)	72 (16)	74 (12)	81 (22)	77 (33)	75 (26)	75 (14)	72 (21)	87 (30)	> 20				
Leakage test	mbar	1	0	0	1	1	1	0	2	1	0	0	1	1	1	<2 mbar pressure drop				
Weight (without tubing)	g	2	50 (0,4)	50 (0,3)	51 (0,4)	50 (0,3)	51 (0,7)	51 (1)	51 (0,6)	50 (0,4)	50 (0,3)	50 (0,4)	50 (0,2)	50 (0,4)	51 (0,1)	48 - 53				
Thickness (double film)	µ	2	468 (10)	492 (3)	504 (12)	483 (15)	498 (14)	475 (17)	487 (13)	450 (17)	478 (7)	484 (15)	466 (17)	490 (19)	490 (9)	402 - 516				
Seal width Drain to film	mm	1	5 (0)	5 (0)	5 (0)	5 (0)	5 (0)	5 (0)	5 (0)	5 (0)	5 (0)	5 (0)	5 (0)	5 (0)	5 (0)	5mm +/- 1 mm				
Seal strength Drain to film	N/15mm	1	91 (0,7)	100 (0,7)	98 (0,7)	98 (10)	103 (7)	94 (7)	91 (6)	98 (18)	102 (5)	91 (15)	99 (15)	97 (10)	90 (19)	> 55				
Film tear strength	Mpa	3																		
Initial force MD	mm	3	17 (1,5)	22 (7)	19 (1,1)	19 (1,1)	20 (2,6)	33 (3,6)	18 (2)	18 (2,1)	18 (0,8)	17 (4,7)	17 (1,9)	19 (6,1)	18 (1,0)	> 3				
Initial force TD	mm	3	32 (1,3)	33 (0,7)	33 (3,1)	40 (4,3)	34 (3,4)	46 (2,1)	39 (3,9)	34 (2,7)	30 (6,1)	33 (1,5)	36 (7,2)	34 (1,9)	38 (2,2)	> 12				
Average force MD	mm	2	16 (1)	22 (6,8)	18 (0,7)	18 (0,5)	18 (1,1)	30 (3,4)	17 (0,8)	18 (2,3)	17 (0,6)	17 (4,1)	17 (1,8)	17 (1,5)	17 (0,8)	> 3				
Average force TD	mm	2	17 (1)	30 (1,4)	31 (1,4)	36 (3,7)	31 (3,4)	40 (1,9)	35 (2,4)	30 (2,2)	27 (5,6)	31 (1,9)	33 (5,8)	29 (3,6)	35 (1,6)	> 12				
Length of bag	mm	3	187 (0)	187 (0)	187 (0)	187 (0,4)	187 (0)	187 (0)	187 (0)	187 (0,4)	187 (0)	187 (0)	187 (0)	187 (0)	187 (0)	187 +/- 1 mm				
Width of bag	mm	3	188 (0,5)	188 (0,6)	187 (0,5)	187 (0,5)	187 (0,5)	187 (0,4)	188 (0,5)	187 (0,5)	188 (0,6)	187 (0,5)	187 (0,5)	188 (0,5)	187 (0,4)	188 +/- 1 mm				
Appearance comments film	mm	2	20 (1)	1	1	1	1	1	1	1	1	1	1	1	1	1 or 2				
Appearance comments drain	mm	2	21 (1)	1	1	1	1	1	1	1	1	1	1	1	1	1 or 2				
IR spectrum film match	mm	2	91	98	92	87	87	96	96	94	84	97	97	96	85	> 70				
IR spectrum drain match	mm	2	99	98	86	95	86	91	93	86	90	93	97	87	97	> 70				
Chemical Compatibility			Blanco	Resistant	Resistant	Resistant	Resistant	Resistant	Resistant	Resistant	Resistant	Resistant	Resistant	Resistant	Resistant	Resistant	Resistant	Resistant	Resistant	Resistant

3 hours – 50 °C

Properties	Units	Ranking	3 hours – 50 °C			Spec on 1 lot only (after 50 kG gamma)
			Blanco	Blanco WFI	Eau de Javel 15° + NaOH 0,5M	
Solvent nr			BL50	WFI50	Javel	
Seal strength Film to film	N/1 5mm	1	97(6)	87 (10)	82 (3,4)	> 60
Seal width Film to film	mm	1	5 (0)	5 (0)	5 (0)	5 mm +/- 1 mm
Film strength MD	N/15 mm	1	30 (1,3)	28 (1,0)	28 (1,9)	> 19
TD			33 (1,0)	24 (3,6)	24 (4,3)	
Elongation MD	%	2	130 (19)	113 (12,6)	115 (24)	> 65
TD			96 (8,3)	51 (25)	55 (25)	> 20
Leakage test	mbar	1	1	0	0	<2 mbar pressure drop
Weight (without tubing)	g	2	51 (0,6)	50 (0,4)	50 (0,2)	48 - 53
Thickness (double film)	μ	2	481 (23)	469 (11)	468 (11)	402 - 516
Seal width Drain to film	mm	1	5 (0)	5 (0)	5 (0)	5 mm +/- 1 mm
Seal strength Drain to film	N/15 mm	1	100 (13)	85 (11)	86 (17)	> 55
Film tear strength Initial force MD	Mpa	3	20 (2,6)	18 (4,9)	17 (1,7)	> 3
Initial force TD			40 (7,9)	43 (2,6)	41 (5)	> 12
Average force MD			20 (1,8)	18 (4,1)	17 (1,5)	> 3
Average force TD			36 (8,0)	37 (2,6)	35 (2,4)	> 12
Length of bag (without seal)	mm	3	187 (0)	188 (0)	187 (0)	187 +/- 1 mm
Width of bag (without seal)	mm	3	187 (0,5)	187(0,5)	187 (0,5)	188 +/- 1 mm
Appearance comments film		2	1	1	1	1 or 2
Appearance comments drain		2	1	1	1	1 or 2
IR spectrum film match		2	96	89	85	> 70
IR spectrum drain match		2	96	97	94	> 70
Conclusion			Blanco	Resistant	Resistant	Resistant
Chemical Compatibility						

3 hours - 60°C

Properties	Units	Ranking	Blanco	Blanco WFI	Acetic acid	NaOH 50%	Spec (after 50 kG gamma)
Bag label			BL-60	WFI-60	Acetic	NaOH	
Seal strength Film to film	N/15 mm	1	87 (5,8)	91 (13)	90 (8,3)	87 (15)	> 60
Seal width Film to film	mm	1	5 (0)	5 (0)	5 (0)	5 (0)	5 mm +/- 1 mm
Film strength MD	N/15 mm	1	28 (1,3)	28 (1,5)	27 (2,1)	27 (2,0)	> 19
TD			31 (0,6)	28 (3,5)	26 (3,5)	29 (3,1)	
Elongation MD	%	2	115 (7,6)	110 (23)	105 (31)	111 (23)	> 65
TD			83 (4,2)	72 (30)	61 (23)	75 (18)	> 20
Leakage test	mbar	1	1	0	1	1	<2 mbar pressure drop
Weight (without tubing)	g	2	50 (0,5)	51 (0,4)	50 (0,1)	51 (0,7)	48 - 53
Thickness (double film)	μ	2	472 (13)	477 (14)	466 (11)	471 (11)	402 - 516
Seal width Drain to film	mm	1	5 (0)	5 (0)	5 (0)	5 (0)	5 mm +/- 1 mm
Seal strength Drain to film	N/15 mm	1	94 (8,5)	83 (11)	84 (6)	94 (8,7)	> 55
Film tear strength	Mpa	3					
Initial force MD			20 (2,9)	18 (1,3)	16 (2)	19 (2,2)	> 3
Initial force TD			45 (6,7)	52 (5,1)	46 (4,5)	41 (9,3)	> 12
Average force MD			20 (2,1)	18 (1,4)	17 (1,6)	18 (3,4)	> 3
Average force TD			38 (6,1)	46 (4,6)	39 (5)	35 (7,5)	> 12
Length of bag	mm	3	187 (0)	187 (0)	187 (0)	187 (0)	187 +/- 1 mm
Width of bag	mm	3	188 (0,5)	187(0,5)	187 (0,6)	187 (0)	188 +/- 1 mm
Appearance comments film		2	1	1	1	1	1 or 2
Appearance comments drain		2	1	1	1	1	1 or 2
IR spectrum film match		2	93	95	96	97	> 70
IR spectrum drain match		2	98	94	92	86	> 70
Conclusion			Blanco	Resistant	Resistant	Resistant	Resistant
Chemical Compatibility							

General conclusion: The Allegro TK8 film is resistant to all tested solutions at the given temperatures and contact times.

E. Statement on TSE/BSE and animal derived components

The entire Allegro TK8 film structure is animal derived component free (ADCF).

Therefore this material is considered safe to use in respect with BSE and TSE transmissions according the Note for guidance on minimizing the risk of transmitting animal spongiform encephalopathy agents via human and veterinary products (EMA/410/01 rev. 3 –July 2011).



Life Sciences

Corporate Headquarters

Port Washington, NY, USA
+1.800.717.7255 toll free (USA)
+1.516.484.5400 phone
biopharm@pall.com e-mail

European Headquarters

Fribourg, Switzerland
+41 (0)26 350 53 00 phone
LifeSciences.EU@pall.com e-mail

Asia-Pacific Headquarters

Singapore
+65 6389 6500 phone
sgcustomerservice@pall.com e-mail

Filtration. Separation. Solution.SM

Visit us on the Web at www.pall.com/allegro

E-mail us at allegro@pall.com

International Offices

Pall Corporation has offices and plants throughout the world in locations such as: Argentina, Australia, Austria, Belgium, Brazil, Canada, China, France, Germany, India, Indonesia, Ireland, Italy, Japan, Korea, Malaysia, Mexico, the Netherlands, New Zealand, Norway, Poland, Puerto Rico, Russia, Singapore, South Africa, Spain, Sweden, Switzerland, Taiwan, Thailand, the United Kingdom, the United States, and Venezuela. Distributors in all major industrial areas of the world. To locate the Pall office or distributor nearest you, visit www.pall.com/contact.

The information provided in this literature was reviewed for accuracy at the time of publication. Product data may be subject to change without notice. For current information consult your local Pall distributor or contact Pall directly.

© 2015, Pall Corporation. Pall,  and Allegro are trademarks of Pall Corporation. ® indicates a trademark registered in the USA and TM indicates a common law trademark. **Filtration.Separation.Solution.** is a service mark of Pall Corporation.

4/15, PDF, GN15-6183

USTR3008