



Pall Corporation

# Ultipleat® Polymer Candle Technology ...



Designed with the  
Polymer Market in Mind

# Ultipleat Polymer Candle Elements – Innovation Throughout

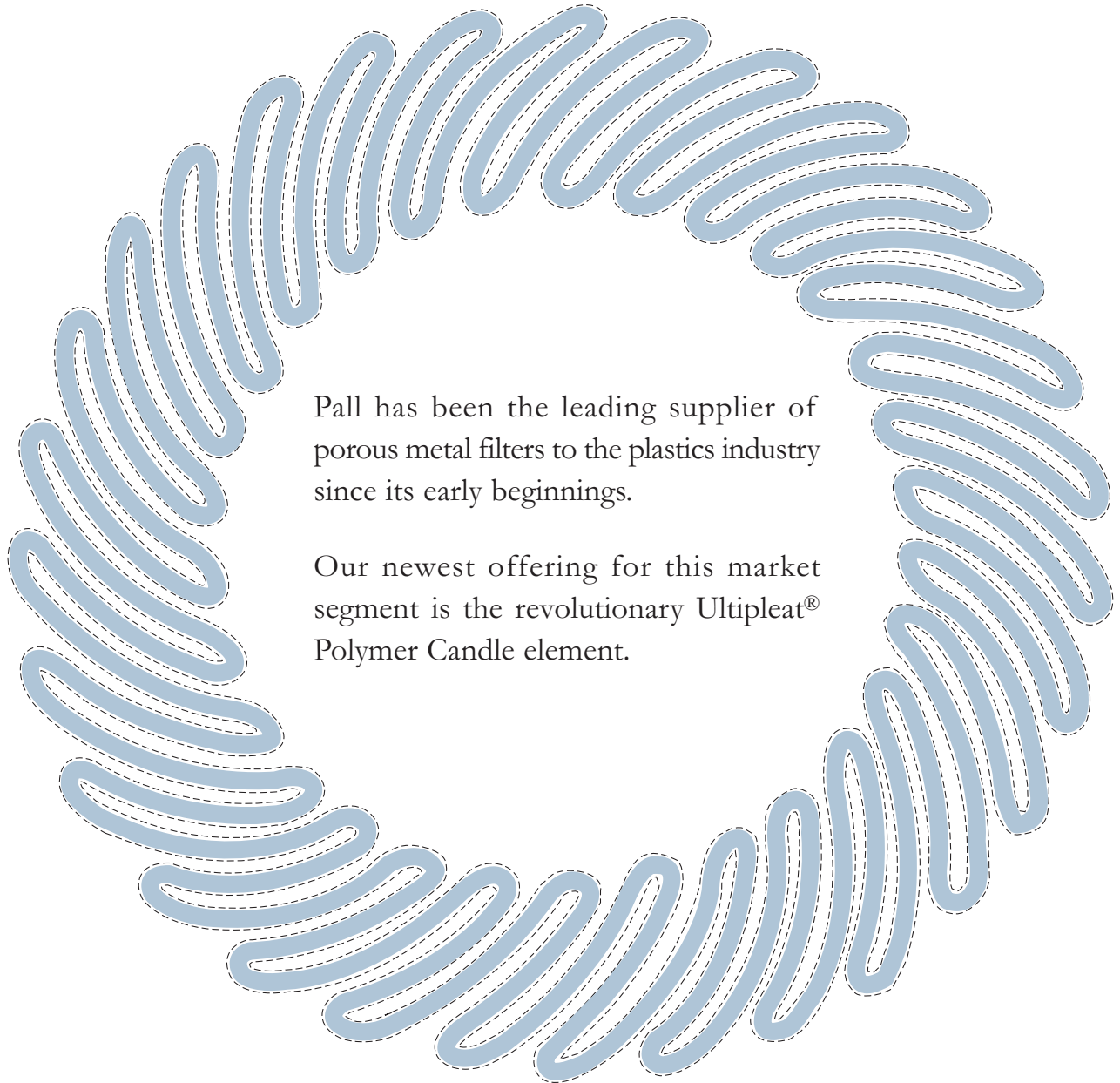

Pall has been the leading supplier of porous metal filters to the plastics industry since its early beginnings.

Our newest offering for this market segment is the revolutionary Ultipleat® Polymer Candle element.

## **Longer Service Life and Finer Filtration**

Pall is able to produce a filter that yields a 30-50% increase in filtration area over traditional fan-pleat filter elements by better utilizing the filter's available space. Higher area, coupled with uniform flow distribution, results in a significant increase in effective dirt-holding capacity. All of this equates to an extended on-stream life and improved melt quality. Alternatively, this increased area can be used to produce a filter element with-finer medium that has the same dirt-holding capacity.

Increased filter area is part of the reason behind the superior performance of this polymer filter - uniform flow is another.

### Uniform Flow Distribution Over the Filter's Entire Surface Area

The fluid flow is completely uniform across the entire filter medium surface since each flow channel is the same width and length on either side of the pleated filter medium (see Figure 1).

Engineered upstream support and downstream drainage layers maintain uniform flow distribution, even as the candle reaches high differential pressures. These layers, which sandwich the filter medium, hold the flow channels open. An external helical wire wrap surrounding the outer diameter of the cartridge holds the pleats in place and prevents them from moving under pressure. The external wire wrap also provides support to the candle during reverse pressure and offers protection to the medium during handling (see Figure 2).

Uniform flow distribution also facilitates a more thorough and complete cleaning of the element. Because the contaminant is uniformly deposited on the medium and not driven into it, it is easily removed. Contaminant removal is also easier as the space between each pleat remains the same over the filter's entire life, even after multiple cleaning cycles.

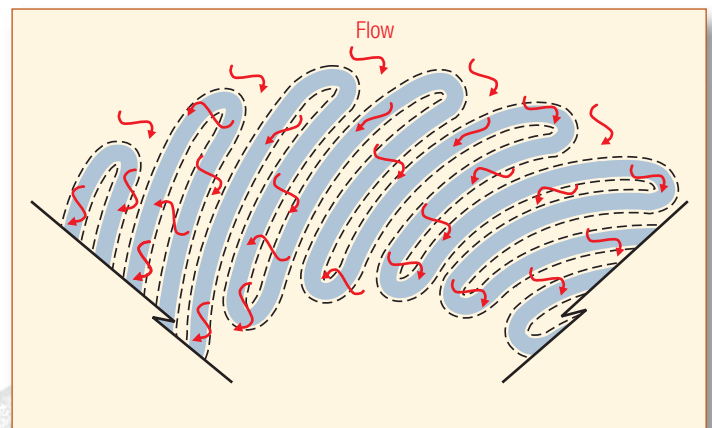

Figure 1: Uniform flow distribution of an Ultipleat filter

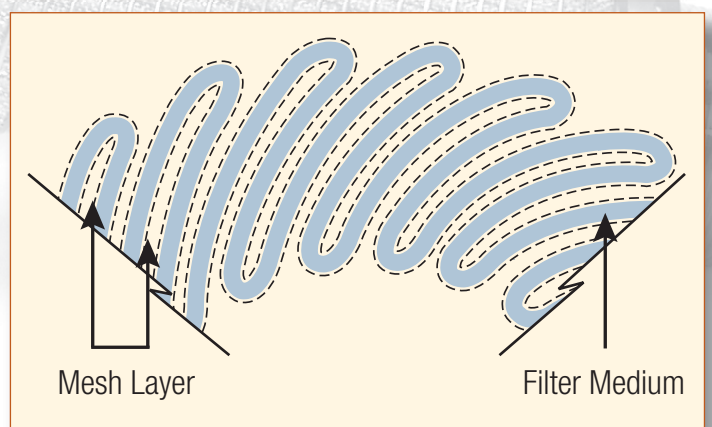

Figure 2: Ultipleat filter element construction

# Pall Media – Engineered for Polymer Service

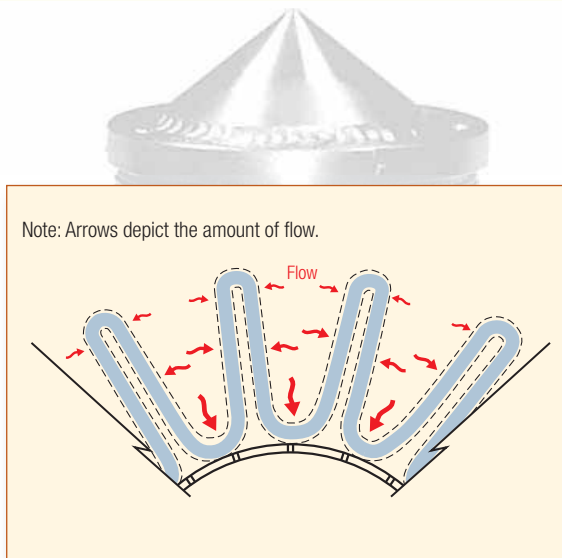

Figure 3: Non-uniform flow distribution in a traditional fan-pleat filter

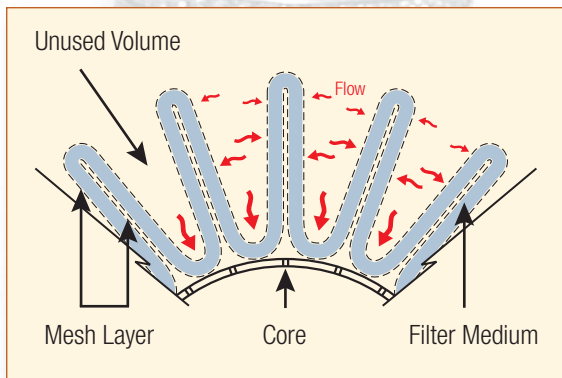

Figure 4: Conventional pleated filter element construction

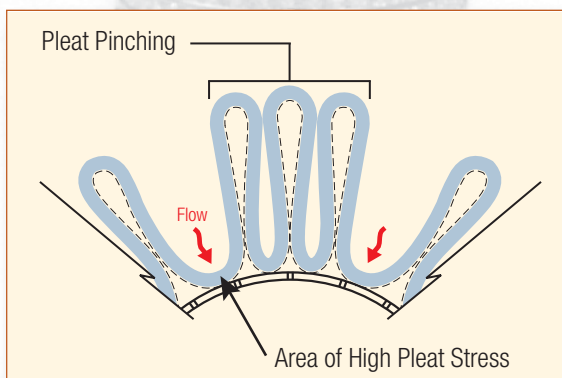

Figure 5: Pleat instability in a poorly supported filter element

In comparison, the flow channel in a conventional fan pleat polymer candle is non-uniform with the upstream of the medium being much more open than the downstream side (see Figure 3).

Consequently, the flow is highest at the bottom of the pleat. Such non-uniform flow distribution results in rapid medium plugging where the flow is the highest. In addition, non-uniform flow through a conventional filter medium causes inconsistent particle removal and poor gel removal.

The drainage and support material used in conventional polymer filters is generally light-strength meshes. After prolonged use in operation and multiple cleaning cycles, these meshes usually weaken, causing the pleats to be pinched or pushed together. The result is low flow through such grouped regions, reduced effective filter area, very short filter life, and difficulties cleaning the element (see Figures 4 & 5).

**In contrast to conventional polymer filters, our innovative Ultipleat Polymer Candles offer:**

- Uniform flow distribution
- Improved melt quality
- Maximum filter life
- Consistent particle removal characteristics
- Low resistance to flow for long periods of time
- Ease of element cleaning

## Smaller Polymer Filter System

With almost double the area per conventional filter cartridge, the Ultipleat Polymer Candle requires approximately half the number of filter cartridges for a given flow rate. As a result, a Pall CPF System using Ultipleat Polymer Candles will have a much smaller footprint than competitive systems with the same area. All of this translates into lower operational costs and lower capital costs for the customer.

At Pall Corporation we ensure the quality of our elements by handling every aspect of production ourselves. In fact, we begin by drawing and processing our own microscopically, fine-metal fiber (available in various thicknesses), which is the sole ingredient in our sintered metal fiber media. With complete control over fiber geometry and media formulations, we can custom-tailor media properties to achieve a desirable goal – such as lower DP, longer life, etc.

**Our application experience is extensive and includes:**

- Acrylics
- Aramids
- Cellulosics
- Engineered resins
- Fluoropolymers
- Polyacrylonitrile
- Polyamides
- Polyaramide
- Polycarbonate
- Polyester
- Polyethylene
- Polypropylene
- Polystyrene
- Polysulfone
- Urethanes



# Pall Media – Engineered for Polymer Service

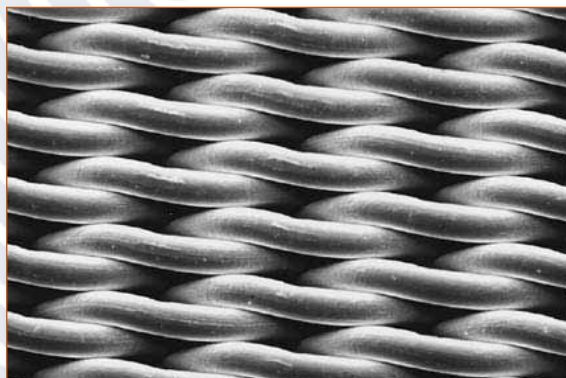
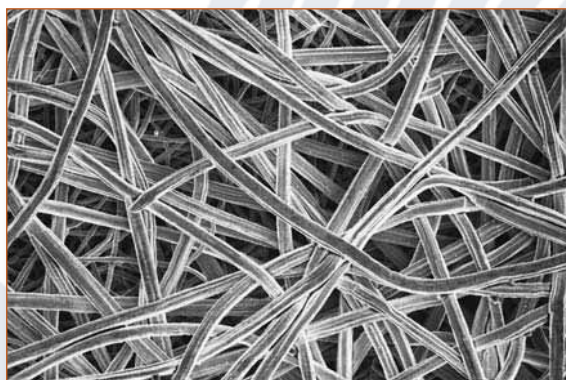

## Dynalloy® Sintered Metal Fiber Media

Ultipleat Polymer Candle filters are available with our depth-type Dynalloy® sintered metal fiber media. The Dynalloy media is highly effective in removing hard and deformable gel-type contaminants. With a porosity of up to 90%, it provides maximum dirt-holding capacity and longer on-stream life than other porous metal media.

Dynalloy media is engineered to withstand high differential pressures, high temperatures, and repeated cleanings. It is available in absolute ratings from 1 to 100 microns and comes in 316L stainless steel as well as a variety of high-temperature, corrosion-resistant alloys.

While Dynalloy media can be custom-designed to your exact specifications, it is also available in two standard formulations. The X Series is a proven performer with high permeability and dirt-holding capacity, offering consistent and reliable filtration. Our advanced 1000 Series incorporates an “asymmetric” graded pore structure for applications requiring an even greater dirt-holding capacity and extended on-stream life.

## Dynamesh™ Woven Wire Cloth Media

Dynamesh™ media is our precision-woven wire cloth, surface-type filter media. This media offers good permeability, narrow pore size distribution, and excellent corrosion resistance. Dynamesh media is specially suited for applications with adverse pressure conditions, low-contaminant loading, and coarser filtration applications. Dynamesh media is available in a variety of grades ranging from 5 to 400 microns.

The full line of Dynamesh media features a variety of weaves, including plain, square, twill, and dutch. Dynamesh media is also available in a full range of stainless steels, as well as Monel<sup>1</sup>, Inconel<sup>1</sup> and Hastelloy<sup>2</sup> grades.

**Result: Economical and reproducible filtration**

<sup>1</sup> – Monel and Inconel are registered trademarks of Special Metals Corporation.

<sup>2</sup> – Hastelloy is a registered trademark of Haynes International, Inc.

## Ultipleat Polymer Candle Features – The Pall Difference

- **Innovation** - durable and cleanable filters for rigorous polymer service.
- **Adapter** - made from Nitronic<sup>3</sup> 60 material. Nitronic 60 material is the best anti-galling and wear-resistant stainless steel available. Nitronic 60 material has outperformed 304 stainless steel in corrosion resistance and is superior to 316/316L stainless steel in pitting resistance. The result is extended thread service life. Conventional candles typically use 304 stainless steel or equivalent material for their adapters.
- **Outer wrap** - unique design to protect the media during handling, operation, and cleaning. The outer wrap is designed to hold the pleat pack and thus maintain the flow channel between pleats during operation and reverse cleaning. Conventional candles have limited purpose and limited open area, making the candle hard to clean.
- **Ultipleat technology** - unique crescent-shaped pleats maximize the filter area per candle. The pleat geometry is designed to create and maintain a uniform flow channel between the pleats to ensure even flow distribution and even residence time distribution, minimizing the possibility of gel creation.
- **Internal hex design (option)** - facilitates element removal/installation and eliminates external wrenching flats and low flow areas at the mounting plate interface.
- **Center support core** - spiral seam-welded, round-holed with maximum open area to prevent concentrated dead space which results in dead flow or longer residence time. Conventional candles typically use straight-seam cores with dead space concentrated along the seam.
- **Streamline construction** allows smooth polymer flow.
- **All metallic 316L fibers** with other alloys also available.
- **100% fiber media** manufactured by Pall.
- **100% integrity tested** in final configuration.
- **Standard and custom designs** are available.

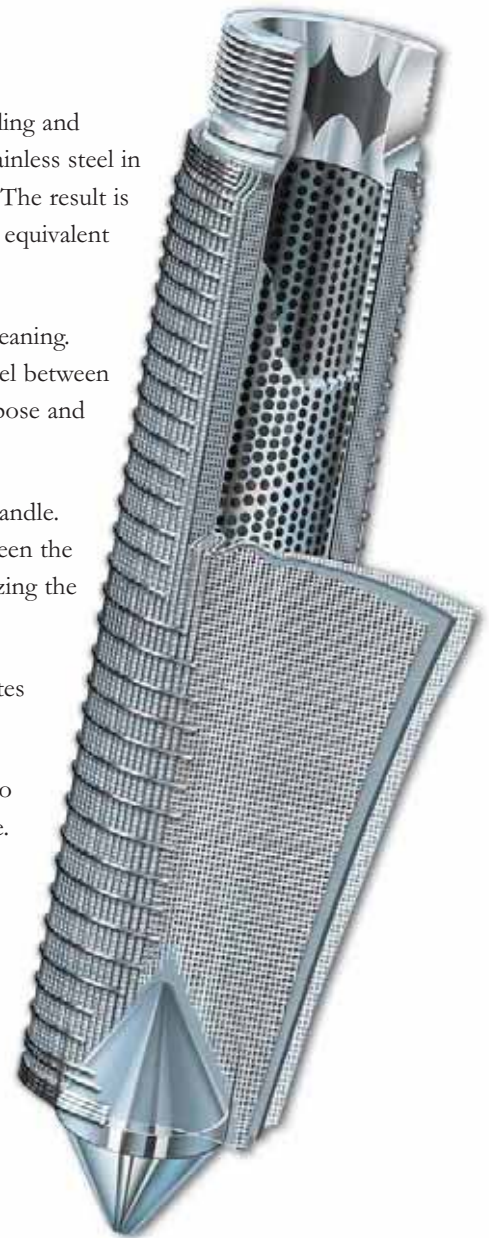

Manufactured from stainless steel and a variety of high-temperature, corrosion-resistant alloys, Pall's Ultipleat Polymer Candle elements are built to be corrosion-resistant, durable, cleanable, and are able to withstand numerous cleaning cycles. Pall uses patented and patent-pending compositions and processes to manufacture these elements.

<sup>3</sup> - Nitronic is a registered trademark of Armco, Inc.

# Pall Corporation –

## Widest Array of Filtration Products for the Polymer Industry



### Segment Filters

Pall polymer segment filters are ideally suited for fine filtration of high-performance polymers with high-viscosity and are highly efficient at removing hard and gel-type contaminants. They are capable of withstanding repeated service and cleaning cycles. Pall's polymer segment filters are available in a wide range of sizes to optimize the performance of new or existing systems.

Our segment elements are available in 178 mm (7.01"), 305 mm (12.01"), and 337 mm (13.27") outer diameters, with hard, semi-hard, or soft center-hub options.



### Pack Disc Filters

Our pack disc filters are designed for point-of-use applications in spin packs and screen changers. Our pleated design increases filter area and significantly extends on-stream life. Pack disc filters are available with rolled or welded rims, in a wide range of standard shapes and sizes, and may be specially designed to meet your requirements. Incorporating our Dynalloy media or Dynamesh media, they are fully cleanable and reusable for long service life. Choose from our wide variety of standard pack disc filters, or select a custom design to meet your specific needs.



### Cartridge Filters

Pall metallic and disposable filter cartridges, in both pleated and simple cylinder constructions, can address your application requirements, including the filtration of raw materials, additives, intermediates, and pre-polymers. No other company offers as wide of an array of cost-effective filtration solutions for the polymer industry as Pall.



## Polymer Systems Performance You Can Count On

In addition to fine fiber, media, and elements, Pall also designs and manufactures complete polymer filter systems, including in-line simplex systems for batch processing and duplex systems for continuous, uninterrupted service. Pall filtration systems are in service around the world, in critical applications throughout the polymer processing industry. Our systems incorporate advances made through our cutting-edge, flow modeling and CAD/CAM technologies. Advanced computer modeling allows Pall engineers to optimize the flow field design for each element tube bundle, diverter valve, and filter housing. The result is a sophisticated filtration system with minimum pressure drop, no low-flow areas, and maximum on-stream life between filter changes.

**More than 2400 Pall CPF Systems are presently in service, indicative of Pall's tried and true performance. Some of the key features of our systems include:**

- **Custom sizing** for each application using a mathematical model to optimize flux distribution and residence time distribution. The result is a streamlined design with minimum pressure drop, maximum on-stream life, and reduced probability of gel formation.
- **Hanging cage design** that drops the housing into the heat exchanger.
- **Ball end mill housing design** allows the outlet housing and element mounting plate to be engineered to form discrete flow channels, reducing residence time and eliminating low flow areas.
- **Asbestos-free, glass fiber insulation** custom-fitted to prevent system heat loss (option).
- **Jack screw assembly** ensures positive seating of housing port to inlet diverter valve.
- **Jacketed, flush-mounted, ram-type vent and drain valves** feature reliable metal-to-metal sealing.
- **Electrically actuated, fully automated (option) spool-type diverter valves** offer unparalleled performance and safety.
- **Custom-fitted, all-stainless steel cover** protects insulation and facilitates cleaning (option).
- **Liquid/vapor heating connections manifold (option)** for ease of installation and maintenance.

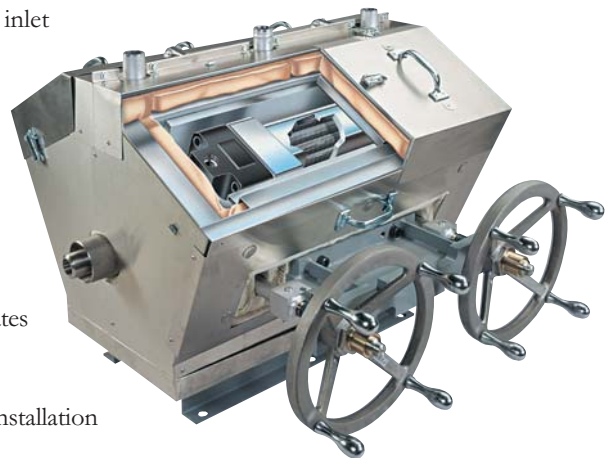
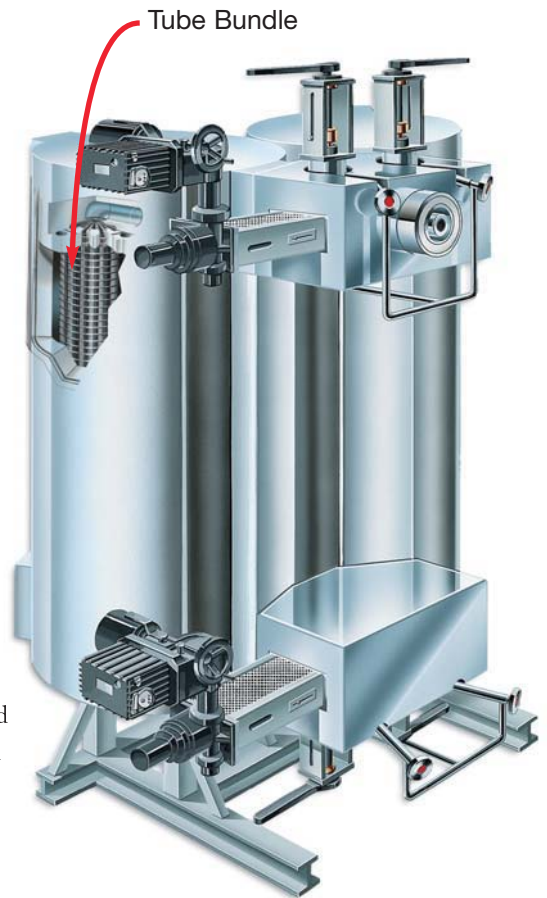

# Productivity and System Support Service

## Services Designed for the Polymer Market

Pall is much more than a filter company. We are fluid management specialists who strive to make our customers' operations more successful. Our Total Fluid Management<sup>SM</sup> (TFM) program consists of a wide range of filtration products and services designed to help customers maintain a specified level of fluid cleanliness, leading to improved operations and system reliability. To this end, we offer a variety of services for polymer processors. We provide these services locally with assistance from Pall's worldwide technical support network. Pall service offerings are available on an as-needed basis or as part of a service contract.

### Typical polymer system services include:

- Flow modeling for analyzing flux distribution and residence time distribution
- Reviewing system installation to ensure optimum performance
- Cleanliness, process, and reliability engineering audits
- Customized product development
- Equipment rental
- Training of plant personnel in all aspects of system operation, maintenance, and troubleshooting
- Rebuilding/diverter and ram valves
- Retrofitting competitive polymer valves to Pall valves
- Upgrading of a polymer system from manually to electronically activated valves
- Element integrity testing through bubble point evaluation
- Cleaning protocol development
- Polymer melt filter trials with an online gel and particle sensor



## You Trust Pall as Your Equipment Supplier, Trust Us to be Your Service Provider

### Typical service offerings include:

- Cleaning protocol development
- Cleanliness/process audits
- Laboratory and pilot testing
- Customized product development
- Commissioning
- Equipment rental
- Remote monitoring
- Training seminars
- Reliability engineering
- Troubleshooting and system support
- System maintenance/service contracts





## Pall Corporation – A Leader in Filtration Technologies

For more than 60 years, Pall Corporation has been solving complex contamination, separations, and purification problems for diverse customers around the globe. Pall is the largest and most diverse filtration, separations, and purifications company in the world. Our products and services allow customers to meet regulatory requirements and increase output while reducing total cost of ownership. Our enabling technologies help make customers' products better, safer, and even possible.

With offices in more than 30 countries, we are well-positioned to provide assistance to customers on the local level, as well as offer broad-based, worldwide support when needed. At the core of our support network is our Scientific and Laboratory Services Department (SLS), an extensive global network of scientists and engineers who are experts in their field.

We invite you to learn more about Pall's wide array of products and services. For more information, contact your Pall representative or visit us on the web at: [www.pall.com](http://www.pall.com).



Pall Corporation

### United States

25 Harbor Park Drive  
Port Washington, New York 11050  
+1 888 873 7255 (toll free in U.S. only)  
+1 516 484 3600 phone  
+1 516 484 0364 fax

### United Kingdom

Europa House  
Havant Street  
Portsmouth  
PO1 3PD  
+44 (0) 23 9230 2357 phone  
+44 (0) 23 9230 2509 fax

### Asia

No. 17 Changi Business Park Central 1,  
#06-01/04, Honeywell Building,  
Singapore 486073  
+65 6389 6500 phone  
+65 6389 6501 fax

### Visit us on the Web at [www.pall.com](http://www.pall.com)

Pall Corporation has offices and plants throughout the world in locations including: Argentina, Australia, Austria, Belgium, Brazil, Canada, China, France, Germany, India, Indonesia, Ireland, Italy, Japan, Korea, Malaysia, Mexico, the Netherlands, New Zealand, Norway, Poland, Puerto Rico, Russia, Singapore, South Africa, Spain, Sweden, Switzerland, Taiwan, Thailand, United Kingdom, United States, and Venezuela. Distributors are located in all major industrial areas of the world.



© Copyright 2008 Pall Corporation. Pall, , Dynalloy, Dynamesh, and Ultipleat are trademarks of Pall Corporation. ® indicates a Pall trademark registered in the USA. Filtration. Separation. Solution.<sup>sm</sup> and Total Fluid Management are service marks of Pall Corporation.

Monel and Inconel are registered trademarks of Special Metals Corporation. Hastelloy is a registered trademark of Haynes International, Inc. Nitronic is a registered trademark of Armco, Inc.

*Filtration. Separation. Solution.<sup>sm</sup>*

PIULTPOLYEN

printed in USA • 6/08 • 3M • ASP