

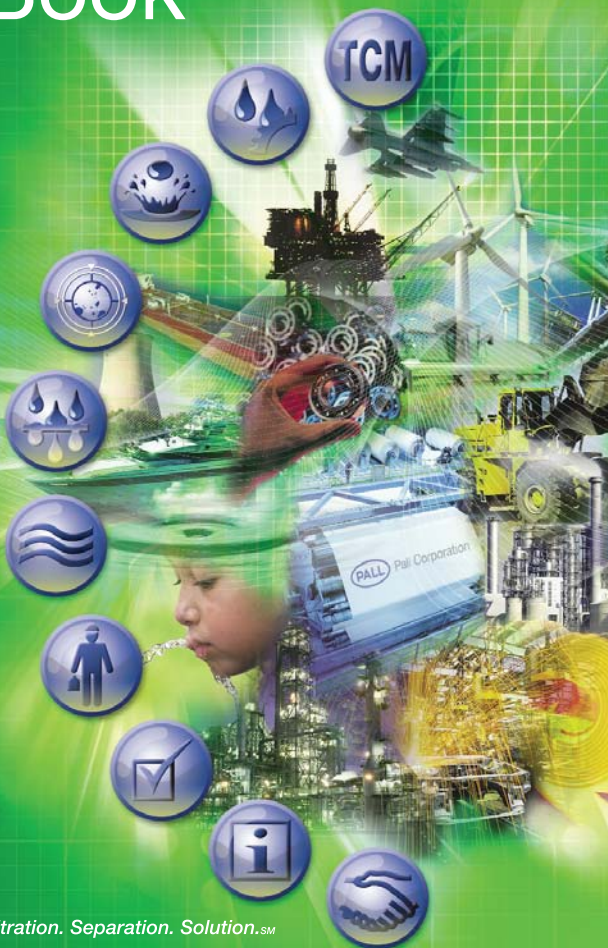

Pall Corporation

# Pocket Book



ENABLING A  
GREENER  
FUTURE™

Filtration. Separation. Solution.<sup>SM</sup>

## Enabling a Greener Future

Businesses worldwide are challenged to conserve energy and resources while protecting the environment. Pall Corporation helps customers achieve these goals by providing leading-edge filtration and separation technologies that purify and conserve water, consume less energy, make alternative energy sources possible and practical and minimize emissions and waste. Our collective efforts are enabling a greener, safer, more sustainable future.

[www.pall.com/green](http://www.pall.com/green)



ENABLING A  
GREENER  
FUTURE<sup>SM</sup>



# Equipment Life Expectancy Factors

A study by Dr. E Rabinowicz at M.I.T. observed that 70% of component replacements or 'loss of usefulness' is due to surface degradation. In hydraulic and lubricating systems, 20% of these replacements result from corrosion with 50% resulting from mechanical wear.

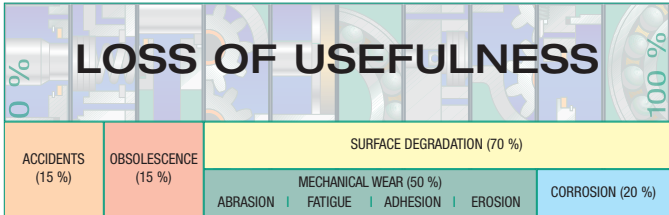

Presented at the American Society of Lubrication Engineers, Bearing Workshop.

# Sources of Contamination

## Built-in contaminants from components:

- Assembly of system
- Cylinders, fluids, hydraulic motors, hoses and pipes, pumps, reservoirs, valves, etc.

## Generated contaminants:

- Operation of system
- Break-in of system
- Fluid breakdown

## External ingress:

- Reservoir breathing
- Cylinder rod seals
- Bearing seals
- Component seals

## Contaminants introduced during maintenance:

- Disassembly/assembly
- Make-up oil

# The Micrometre "µm"

'Micron' = micrometre =  $\mu\text{m}$

The micrometre is the standard for measuring particulate contaminants in lubricating and fluid power systems.

1 micron = 0.001 mm (0.000039 inch)

10 micron = 0.01 mm (0.0004 inch)

Smallest dot you can see with the naked eye = 40  $\mu\text{m}$

Thickness of a human hair = 75  $\mu\text{m}$

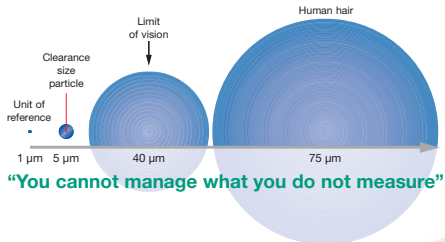

# Mechanisms of Wear

## Abrasive Wear

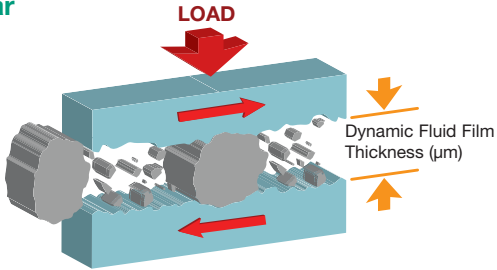

### Abrasive Wear Effects:

- Dimensional changes
- Leakage
- Lower efficiency
- Generated wear: more wear

### Typical components subjected to Abrasion:

- All hydraulic components: pumps, motors, spool valves and cylinders
- Hydraulic motors
- Journal bearings

## Adhesive Wear

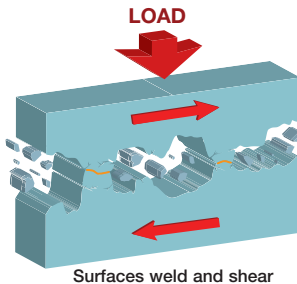

### Adhesive Wear Effects:

- Metal to metal points of contact
- 'Cold Welding'
- Adhesion and shearing

### Typical components subjected to Adhesion:

- Hydraulic cylinders
- Ball bearings
- Journal bearings

## Mechanisms of Wear (continued)

### Fatigue Wear

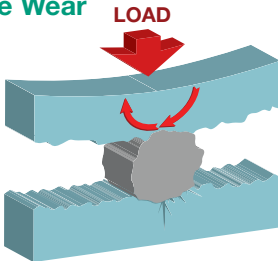

Particle caught, surfaces dented and cracking initiated

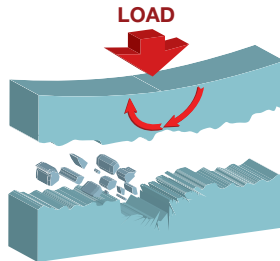

After 'N' fatigue cycles, cracking spreads, surface fails and particles are released

#### Fatigue Wear Effects:

- Leakage
- Deterioration of surface finish
- Cracks

#### Typical components subjected to Fatigue:

- Journal bearings
- Hydrostatic bearings
- Rolling element bearings
- Geared systems

### Erosive Wear

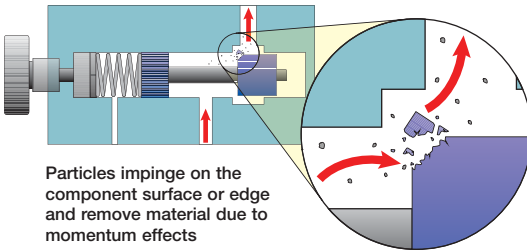

Particles impinge on the component surface or edge and remove material due to momentum effects

#### Erosive Wear Effects:

- Slow response
- Spool jamming/stiction
- Leakage
- Solenoid burnout

#### Typical components subjected to Erosion:

- Servo valves
- Proportional valves
- Directional control valves

## Typical Dynamic (Operating) Clearances

Component	Details	Clearances
Valves	Servo	1 - 4 $\mu\text{m}$
	Proportional	1 - 6 $\mu\text{m}$
	Directional	2 - 8 $\mu\text{m}$
Variable Volume Piston Pumps	Piston to Bore	5 - 40 $\mu\text{m}$
	Valve Plate to Cylinder Block	0.5 - 5 $\mu\text{m}$
Vane Pumps	Tip to Case	0.5 - 1 $\mu\text{m}$
	Sides to Case	5 - 13 $\mu\text{m}$
Gear Pumps	Tooth Tip to Case	0.5 - 5 $\mu\text{m}$
	Tooth to Side Plate	0.5 - 5 $\mu\text{m}$
Ball Bearings	Film Thickness	0.1 - 0.7 $\mu\text{m}$
Roller Bearings	Film Thickness	0.4 - 1 $\mu\text{m}$
Journal Bearings	Film Thickness	0.5 - 125 $\mu\text{m}$
Seals	Seal and Shaft	0.05 - 0.5 $\mu\text{m}$
Gears	Mating Faces	0.1 - 1 $\mu\text{m}$

\*Data from STLE Handbook on Lubrication & Tribology (1994)

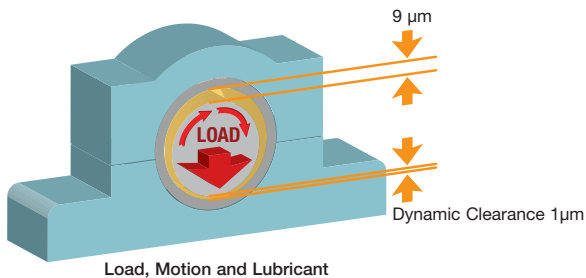

## Fluid Analysis Methods for Particulate

Method	Units	Sampling	Benefits	Limitations
Optical Particle Count	Number/mL/ Cleanliness code	Off-line; Laboratory	Provides size distribution. Unaffected by fluid opacity, water and air in fluid sample	Sample preparation time
Automatic Particle Count (APC)	Number/mL/ Cleanliness code	Off-line; "Sip" from containers; On-line	Fast and repeatable	Sensitive to 'silts', water, air and gels
Filter / Mesh Blockage Technique	Cleanliness code	Off-line; "Sip" from containers; On-line	Not affected by the presence of air or free water in the fluid sample	Does not provide the size distribution of the contamination
Patch Test and Fluid Contamination Comparator	Visual comparison/ Cleanliness code	Off-line; Point of use	Rapid analysis of system fluid cleanliness levels in field. Helps to identify types of contamination	Provides approximate contamination levels
Ferrography	Scaled number of large/small particles	Off-line; Laboratory	Provides basic information on ferrous and magnetic particles	Low detection efficiency on non-magnetic particles e.g. brass, silica
Spectrometry	PPM	Off-line; Laboratory	Identifies and quantifies contaminant material	Limited detection above 5 $\mu\text{m}$
Gravimetric	mg/L	Off-line; Laboratory	Indicates total mass of contaminant	Cannot distinguish particle size. Not suitable for moderate to clean fluids. i.e. below ISO 18/16/13

## Monitoring and Measurement Equipment

### Automatic Particle Counters (APCs)

Automatic particle counters are the most common method used by industry for particulate contamination analysis.

### Principle:

As a particle passes through the light beam, the light intensity received by the photo detector is reduced in proportion to the size of the particle.

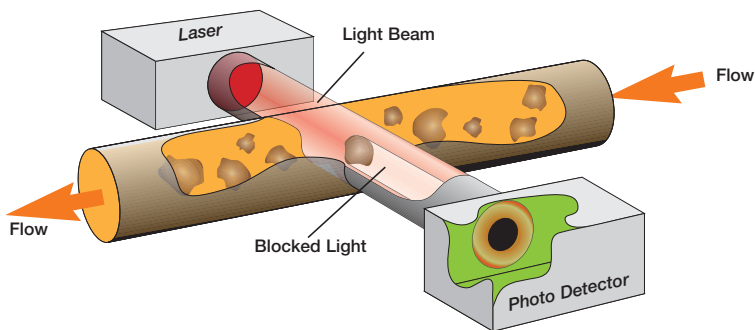

### Mesh Blockage Devices

Filter/mesh blockage devices are an alternative to APCs, especially in conditions where the fluid is opaque or where free water or air is present in the fluid.

### Principle:

Filter/mesh blockage devices determine particulate contamination levels by passing a specified flow of sample fluid through a series of calibrated mesh screens in a specified sequence. Pressure drop build-up (or flow degradation) is dependent on particulate contamination levels. The mesh is cleaned by backflushing.

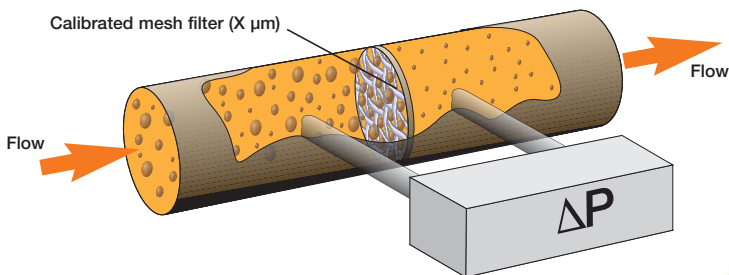



# Monitoring and Measurement Equipment

Obtaining accurate and reliable fluid cleanliness data quickly in order to detect abnormal contamination is a key factor in ensuring the efficiency of industrial processes and reducing downtime.

## Reliable Monitoring Solutions... ...Whatever the Conditions...Whatever the Fluid



### Pull Cleanliness Monitors

Provide an assessment of system fluid cleanliness

- Proven mesh blockage technology
- On-line and off-line modes of operation
- Results not affected by free water or undissolved air contamination
- Designed for use with dark or cloudy fluids
- ISO 4406, or AS4059 (NAS1638) data output
- Water sensor option

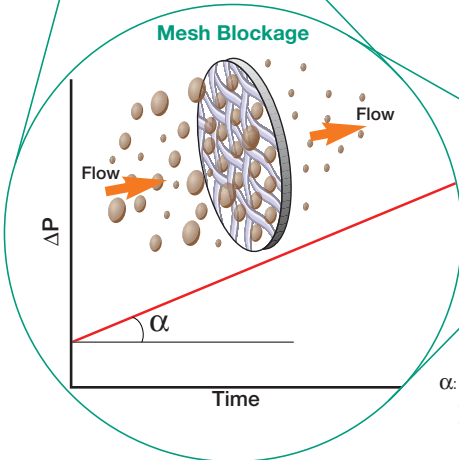

$\alpha$ : Rate of pressure drop increase (slope) across the mesh is based on the level of particulate contamination in the fluid (at constant flow and temperature)

# Understanding the ISO 4406 Cleanliness Code

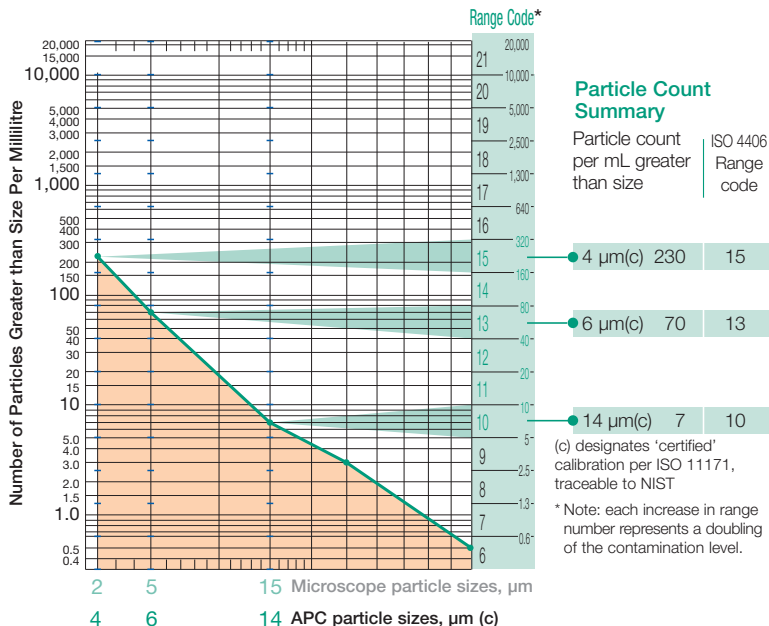

Fluid cleanliness levels found in modern hydraulic systems (typically ISO code <15/13/10 - see the area highlighted in orange) requires on-line monitoring.

The ISO Cleanliness code references the number of particles greater than 4, 6 and 14 µm(c) in one mL of sample fluid.

To determine the ISO Cleanliness code for a fluid, the results of particle counting are plotted on a graph. The corresponding range code, shown at the right of the graph, gives the cleanliness code number for each of the three particle sizes. For the example above the data becomes ISO 15/13/10. Where there is not a requirement for data at the first size or the technique used does not give this data e.g. microscope counts and PCM data, "-" is used, e.g. ISO -/13/10.

The ISO 4406 level for a system depends on the sensitivity of the system to contaminant and the level of reliability required by the user. A method for selecting the level for an individual system (called the "Required Cleanliness Level" or "RCL") is described on Pages 37 and 38.

## ISO 4406 Cleanliness Code 13/11/09

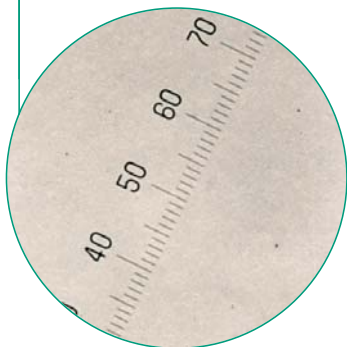

**Sample Volume:** 25 mL using Ø25 mm membrane filter or  
100 mL using Ø47 mm membrane filter

**Magnification:** 100x

**Scale:** 1 division = 10 µm

### Particle Count Summary

Size	Particle Count Range per mL	ISO 4406 Code	SAE AS4059 <sup>1,2</sup> (NAS1638)
>4 µm(c)	52	13	3A
>6 µm(c)	16	11	3B
>14 µm(c)	4	09	3C

### Description

System with  $\beta_{5(c)} > 1,000$  wear control filtration

**Contaminants:** Some black metal

## ISO 4406 Cleanliness Code 19/16/11

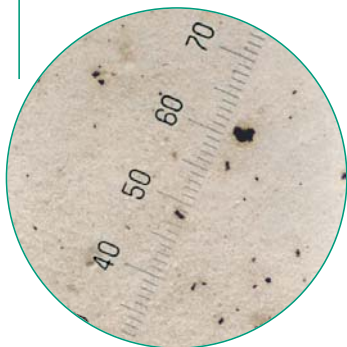

**Sample Volume:** 25 mL using Ø25 mm membrane filter or  
100 mL using Ø47 mm membrane filter

**Magnification:** 100x

**Scale:** 1 division = 10 µm

### Particle Count Summary

Size	Particle Count Range per mL	ISO 4406 Code	SAE AS4059 <sup>1,2</sup> (NAS1638)
>4 µm(c)	4,200	19	10A
>6 µm(c)	540	16	8B
>14 µm(c)	20	11	9C

### Description

System with inadequate filtration.

**Contaminants:** Bright metal, Black metal, Silica, Plastics

<sup>1</sup>AS4059 is based on 100 mL. <sup>2</sup>AS4059 classes are for the 3 ISO 4406 size ranges

## ISO 4406 Cleanliness Code 21/19/16

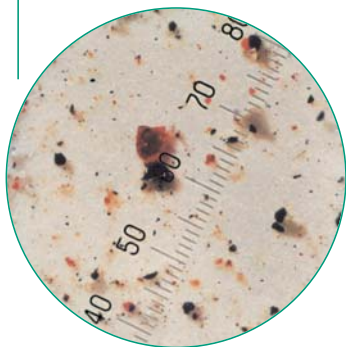

**Sample Volume:** 25 mL using Ø25 mm membrane filter or  
100 mL using Ø47 mm membrane filter

**Magnification:** 100x

**Scale:** 1 division = 10 µm

### Particle Count Summary

Size	Particle Count Range per mL	ISO 4406 Code	SAE AS4059 <sup>1,2</sup> (NAS1638)
>4 µm(c)	12,345	21	11A
>6 µm(c)	3,280	19	11B
>14 µm(c)	450	16	11C

### Description

New oil from barrel

**Contaminants:** Silica, Black metal, Bright metal, Plastics

## ISO 4406 Cleanliness Code 22/20/19

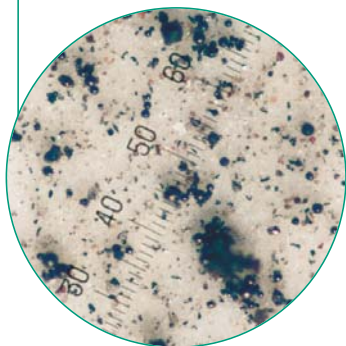

**Sample Volume:** 25 mL using Ø25 mm membrane filter or  
100 mL using Ø47 mm membrane filter

**Magnification:** 100x

**Scale:** 1 division = 10 µm

### Particle Count Summary

Size	Particle Count Range per mL	ISO 4406 Code	SAE AS4059 <sup>1,2</sup> (NAS1638)
>4 µm(c)	31,046	22	12A
>6 µm(c)	7,502	20	12B
>14 µm(c)	1,960	19	12C

### Description

New system with built-in contaminants

**Contaminants:** Bright metal, Black metal, Rust, Silica, Plastics

<sup>1</sup>AS4059 is based on 100 mL. <sup>2</sup>AS4059 classes are for the 3 ISO 4406 size ranges

# On-line Particulate Cleanliness Monitoring

## We cannot control what we cannot measure

### Modes of Analysis

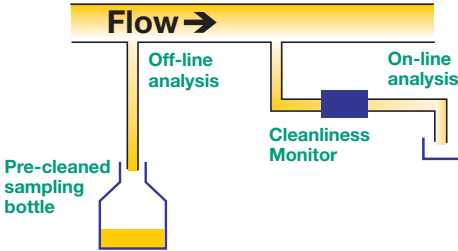

### Comparison of on-line counting and off-line counting

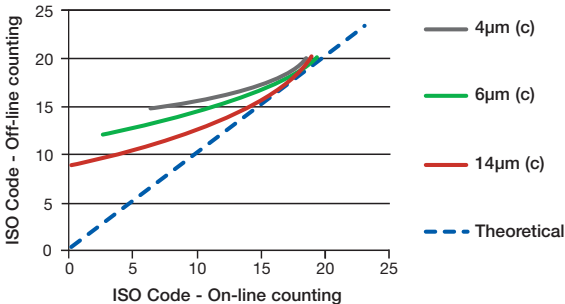

Source : Tampere University of Technology, Finland

At the higher contamination levels (higher ISO codes) there is little difference between the two modes of analysis, but as the oil gets cleaner, the level recorded by the off-line analysis inaccurately shows the oil to be dirtier compared to on-line analysis.

### Factors influencing the accuracy of the off-line analysis:

- Introduction of environmental dirt into sample bottle
- Incorrect cleaning of sample bottle
- Inadequate flushing of sampling valve
- Effectiveness of sampling process

# Fluid Sampling Procedure

## Introduction

There are four methods for taking fluid samples, three for extracting samples and one for on-line analysis. Method 1 is the best choice followed by Method 2. Method 3 should only be used if there is no opportunity to take a line sample.

DO NOT obtain a sample from a reservoir drain valve. Always take the sample under the cleanest possible conditions and use pre-cleaned sample bottles.

**If there are no line mounted samplers, fit a Pall sampling device to the Pall filter.**

### Method 1

#### Small ball valve with PTFE or similar seats, or a test point

1. Operate the system for at least 30 minutes prior to taking sample in order to distribute the particulate evenly.
2. Open the sampling valve and flush at least 1 litre of fluid through the valve. Do not close the valve after flushing.
3. When opening the sample bottle, be extremely careful not to contaminate it.
4. Half fill the bottle with system fluid, use this to rinse the inner surfaces and then discard.
5. Repeat step 4 a second time without closing the valve.
6. Collect sufficient fluid to fill 3/4 of bottle (to allow contents to be redistributed).
7. Cap the sample immediately and then close the sample valve.  
**Caution: Do not touch the valve while taking the sample.**
8. Label the sample bottle with system details and enclose in a suitable container for transport.

### Method 2

#### Valve of unknown contamination shedding capabilities

1. Operate the system for at least 30 minutes prior to taking sample in order to distribute particulate evenly.
2. Open the sampling valve and flush at least 3 to 4 Litres of fluid through the valve. (This is best accomplished by connecting the outlet of the valve back to the reservoir by using flexible tubing). Do not close the valve.
3. Having flushed the valve, remove the flexible tubing from the valve with the valve still open and fluid flowing. Remove the cap of the sample bottle and collect sample according to instructions 4 to 6 of Method 1.
4. Cap the sample immediately and then close the sample valve.  
**Caution: Do not touch the valve while taking the sample.**
5. Label the sample bottle with system details and enclose in a suitable container for transport.

## Fluid Sampling Procedure (continued)

### Method 3

#### Sampling from Reservoirs and Bulk Containers

Applicable only if Methods 1 and 2 cannot be used

1. Operate the system for at least 30 minutes prior to taking sample in order to distribute the particles evenly.
2. Clean the area of entry to the reservoir where sample will be obtained.
3. Flush the hose of the vacuum sampling device with filtered (0.8  $\mu\text{m}$ ) solvent to remove contamination that may be present.
4. Attach a suitable sample bottle to the sampling device, carefully insert the hose into the reservoir so that it is mid-way into the fluid. Take care not to scrape the hose against the sides of the tank or baffles within the tank as contamination may be sucked into the hose.
5. Pull the plunger on the body of the sampling device to produce vacuum and half fill the bottle.
6. Unscrew bottle slightly to release vacuum, allowing hose to drain.
7. Flush the bottle by repeating steps 4 to 6 two or three times.
8. Collect sufficient fluid to 3/4 fill the sample bottle, release the vacuum and unscrew the sample bottle. Immediately recap and label the sample bottle.

### Method 4

#### On-line Analysis

This procedure is for portable instruments that have to be connected to the system

1. Check that the sampling position satisfies the reason for sampling and the sampling valves/points complies with the requirements of Method 1;
2. Check that there is sufficient supply pressure to avoid instrument starvation or cavitation;
3. Operate the system for at least 30 min
4. Remove any covers, caps etc from the sampling position and, if practical, clean the exterior of the connection point with a clean solvent.
5. Carefully connect the instrument to the sampling point and minimise the generation of dirt
6. Operate the instrument in accordance with the manufacturer's instructions and flush the sampling lines and instrument with a suitable volume of fluid, as specified by the instrument manufacturer. If not a volume equivalent to 10 times the volume of the connection pipes and instrument is appropriate;
7. The analysis shall be continued until the data from successive samples is either:
  - a) within the limits set by the instrument manufacturer; or
  - b) the difference is less than 10 % at the minimum particle size being monitored if the required output is particle count; or
  - c) the same cleanliness code has been recorded.

# Water Contamination in Oil

## Water contamination in oil systems causes:

- Oil breakdown, such as additive precipitation and oil oxidation
- Reduced lubricating film thickness
- Accelerated metal surface fatigue
- Corrosion

## Sources of water contamination:

- Heat exchanger leaks
- Seal leaks
- Condensation of humid air
- Inadequate reservoir covers
- Temperature reduction (causing dissolved water to turn into free water)
- Equipment cleaning via high pressure hose



Corrosion in the resevoir

## Typical Water Saturation Curve

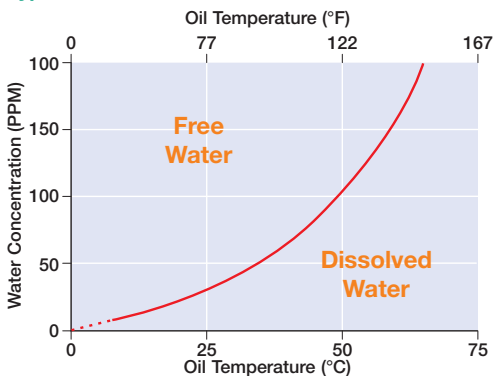

Ref: EPRI CS-4555 Turbine oil



Dissolved, emulsified and free water in oil

To minimize the harmful effects of free water, water concentration in oil should be kept as far below the oil saturation point as possible.

## Water Concentration

10,000 PPM	1%
1,000 PPM	0.1%
100 PPM	0.01%



## Water Content Analysis Methods

Method	Units	Benefits	Limitations
Crackle Test	None	Quick indicator of presence of free water	Does not permit detection below saturation
Chemical (Calcium hydride)	Percentage or PPM	A simple measurement of water content	Not very accurate for dissolved water
Distillation	Percentage	Unaffected by oil additives	Limited accuracy on dry oils
FTIR	Percentage or PPM	Quick and inexpensive	Accuracy does not permit detection below 0.1% (1,000 PPM)
Karl Fischer	Percentage or PPM	Accurate at detecting low levels of water (10 - 1,000 PPM)	Not suitable for high levels of water. Can be affected by additives
Capacitive Sensor (Water Sensor)	Percentage of saturation or PPM	Accurate at detecting dissolved water (0 - 100% of saturation)	Cannot measure water levels above saturation (100%)

## Water Sensor Technology

Water contamination in fluids can cause numerous problems such as additive depletion, oil oxidation, corrosion, reduced lubricating film thickness, microbial growth, and reduction of dielectric strength. Water sensors incorporate a probe that can be directly immersed in the fluid to monitor dissolved water content and temperature.

A variety of water sensor models are available including explosion proof options. Contact Pall to determine the most appropriate model for your application.



**WS08**  
In-Line  
Water Sensor



**WS10**  
In-Line  
Water sensor



**WS09**  
Portable  
Water Sensor

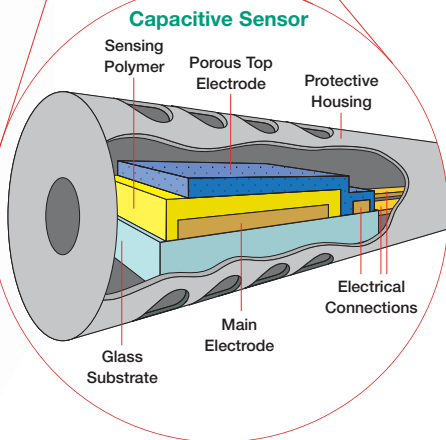

### Capacitive Sensor Principle:

The electrical resistance of the dielectric polymer changes as the relative humidity changes. The water sensor probe is protected to avoid erratic results from solid contaminants settling on the porous top electrode.

# Operating Principle of Pall Fluid Conditioning Purifiers

Principle: Mass transfer by evaporation under vacuum

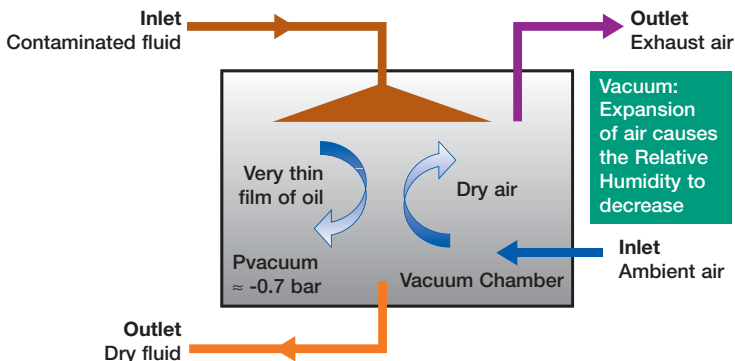

## Removing free water is never enough!

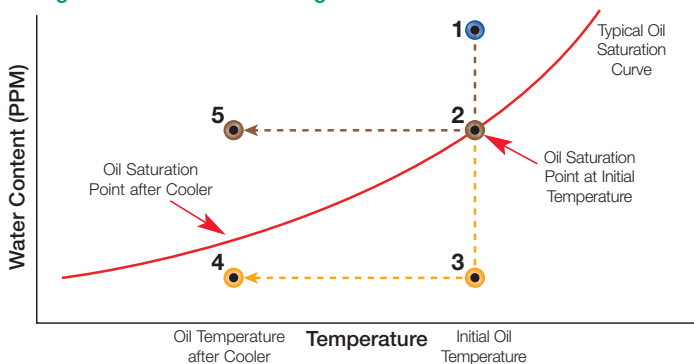

- 1 Initial water content is above saturation (free water).
- 2 Maximum water removal capability of “free water removal” devices (coalescers, centrifuges, etc.) is to the oil’s saturation point.
- 3 Water content achieved with mass transfer dehydration is significantly below the oil’s saturation point.
- 4 Water content achieved with mass transfer dehydration remains below the oil’s saturation point even after oil is cooled. This prevents the formation of harmful free water.
- 5 If only free water is removed at initial temperature, when oil is cooled the amount of harmful free water in the oil can increase significantly.

## Pall Portable Oil Purifiers



Pall HLP6  
HVP Series



Pall HNP022  
HNP Series



Pall HNP074  
HNP Series

Pall oil purifiers are available in a wide range of flowrates: from 10 L/min to 200 L/min (2.6 USgpm to 52.8 USgpm).

**Contact Pall for special variants such as explosion proof, ATEX, or fully remote controlled purifiers**

### Oil Purifier Features

- Removes 100% free and up to 90% dissolved water
- Removes 100% free and up to 90% dissolved gases
- Unlimited water and air removal capacity
- Wide fluid compatibility
- Fully portable for multiple site application
- Simple to operate
- No heating required - does not burn oils
- Low power consumption
- Low operating costs
- Automatic control of the main operating parameters
- Robust and reliable under harsh conditions
- Easy maintenance

### Typical Applications

- Hydraulic oils
- Lubrication oils
- Dielectric oils
- Phosphate-esters
- Quench oils

# Pall Total Cleanliness Management (TCM) for Industrial Manufacturing

Enhancing Fluid Cleanliness, Advancing productivity, Assuring Reliability

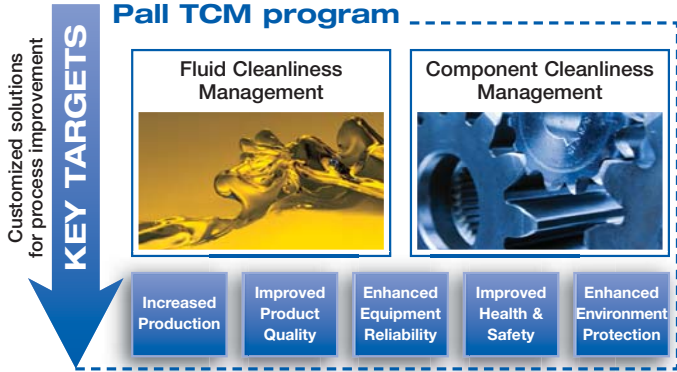

Pall provides customized contamination control solutions to improve system performance and reduce operating costs. Challenge us to deliver sustainable and cost-effective solutions to all your contamination problems.

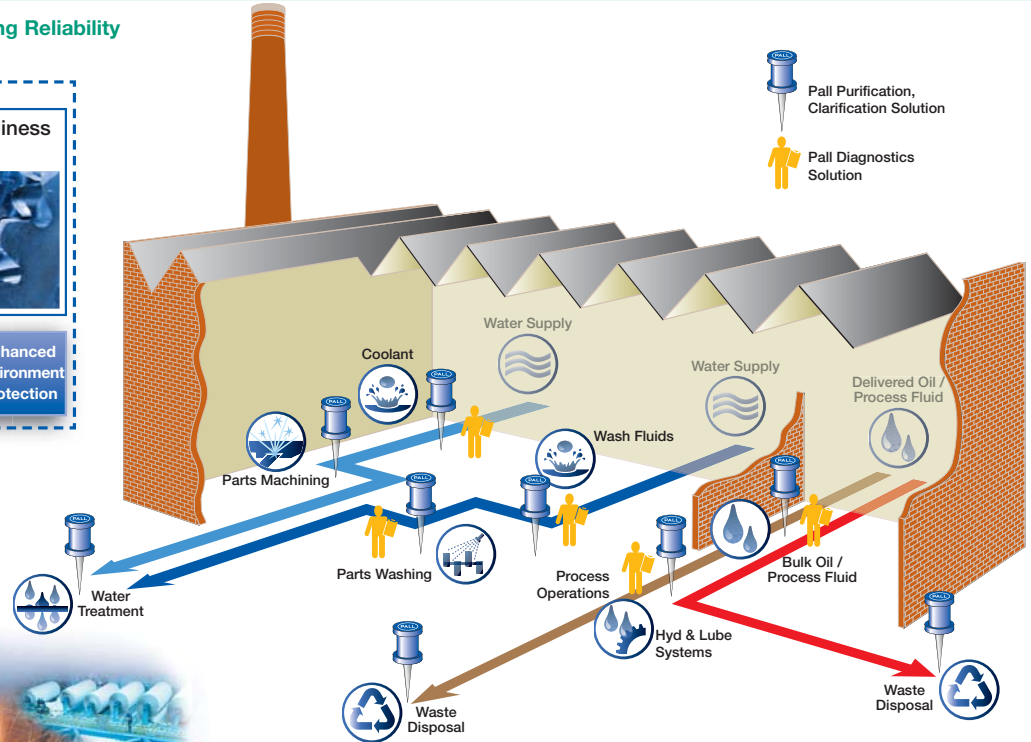

## Examples of applications where the Pall TCM program can be implemented

### Typical Fluids

- Parts washing fluids
- Coolants
- Lubrication oils
- Cutting fluids
- Water glycols
- Dielectric oils
- Process fluids
- Fuels
- Phosphate-esters
- Water
- Solvents
- Quench oils
- Hydraulic oils



# Short Element Life Checklist

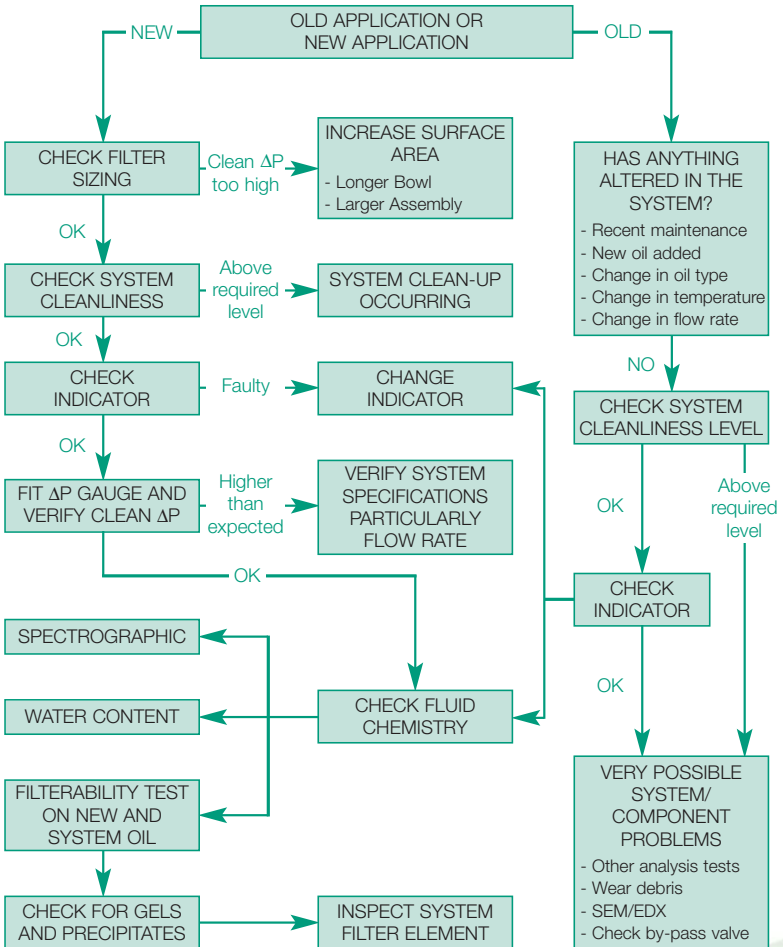

# Lube and Hydraulic Filter Locations

## Pressure Line

- To stop pump wear debris from travelling through the system
- To catch debris from a catastrophic pump failure and prevent secondary system damage
- To act as a Last Chance Filter (LCF) and protect components directly downstream of it

## Return Line

- To capture debris from component wear or ingress travelling to the reservoir
- To promote general system cleanliness

## Kidney loop/off-line

- To control system cleanliness when pressure line flow diminishes (i.e. compensating pumps)
- For systems where pressure or return filtration is impractical
- As a supplement to in-line filters to provide improved cleanliness control and filter service life in high dirt ingress systems

## Reservoir Air Breather

- To prevent ingress of airborne particulate contamination
- To extend system filter element service life
- To maintain system cleanliness

## Additional filters should be placed ahead of critical or sensitive components

- To protect against catastrophic machine failure (often non-bypass filters are used)
- To reduce wear
- To stabilize valve operation (prevents stiction)

## Flushing Filter

- To remove particles that have been built-in to the system during assembly or maintenance before start-up
- To remove large particles that will cause catastrophic failures
- To extend 'in-service' filter element life

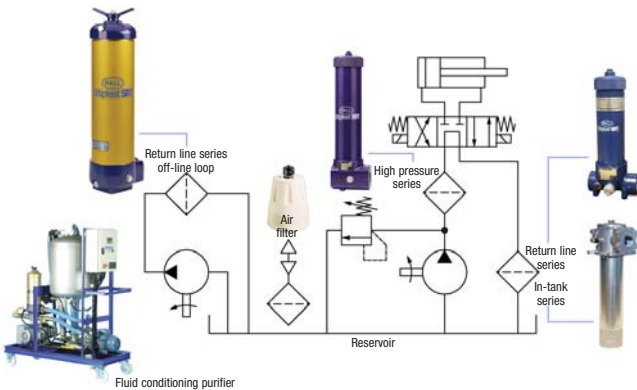

## Flushing Recommendations

The aim of flushing is to remove contamination from the inside of pipes and components that are introduced during system assembly or maintenance. This is accomplished by passing clean fluid through the system, usually at a velocity higher than that during normal operation to pick up the particles from the surface and transport them to the flushing filter.

**Omission or curtailment of flushing will inevitably lead to rapid wear of components, malfunction and breakdown.**

**Reynolds Number (Re):** A non-dimensional number that provides a qualification of the degree of turbulence within a pipe or hose.



Laminar Flow



Turbulent Flow

Laminar Flow -  $Re < 2,000$

Transitional Flow -  $Re 2,000 - 4,000$

Turbulent Flow -  $Re > 4,000$

**For effective flushing procedures the Reynolds Number (Re) should be in excess of 4000**

The flow condition in a pipe or hose can be assessed using Reynolds Number (Re) as follows:

$$Re = \frac{Ud}{\nu} \times 1,000$$

or

$$Re = 21,200 \times Q / (\nu \times d)$$

Re = Reynolds Number

U = Mean flow velocity (m/s)

d = Pipe internal diameter (mm)

$\nu$  = Kinematic viscosity of fluid in cSt ( $\text{mm}^2/\text{s}$ )

Q = Flow rate (L/min)



# Filters for Hydraulic and Lubricating Fluids

Whatever your application in hydraulics or lubrication, Pall offers the most innovative filtration technology available to achieve the optimum cleanliness levels of your fluids.

## Pall Filters Offer:

- $\beta \geq 1000$  removal efficiency
- Low, clean differential pressure
- Long service life
- Environmentally friendly coreless filter pack



## Pall Filtration Milestones

- 1965 – Ultipor Filters
- 1966 – Ultipor Dirt Fuse Filters
- 1986 – Ultipor II Filters
- 1986 – Ultipor II Dirt Fuse Filters
- 1991 – Ultipor III Filters
- 1991 – Ultipor III Dirt Fuse Filters
- 1993 – Coreless Ultipor III Filters
- 2000 – Ultipor SRT Filters
- 2004 – Ultipleat SRT Filters

## A History of “Industry Firsts”

- Glass fiber filter media 1965
- Fixed pore filter media 1965
- $\beta \geq 75$  filtration ratings 1965
- 3000 psid collapse-rated filters 1966
- Tapered pore filter structure 1986
- Polymeric drainage meshes 1986
- $\beta \geq 200$  filtration ratings 1986
- Helical outer wrap 1990
- Coreless/cageless construction 1993
- $\beta \geq 1000$  filtration ratings 1999
- Stress-resistant filter medium 2000
- ISO Code (CST) filtration ratings 2004
- Laid-over pleating 2004
- Triboelectric charge-resistance 2004
- In-to-out flow path 2004
- Life-extending drainage meshes 2009



## Ultipleat® SRT Filters

Stress resistant technology, anti-static construction, unequalled filtration performance

## A revolutionary filter technology for hydraulic and lube applications

- Smaller size
- Increased resistance to system stresses
- High flow capability
- Improved cleanliness control
- Increased equipment protection
- Triboelectric charge resistance

**Media Substrate Support Layer**  
(not shown): Provides support for the media and aids in drainage flow

**Benefit:** Reliable, consistent performance

### Proprietary Cushion Layer:

Provides support for the media and protection from handling

**Benefit:** Reliable, consistent performance

**O-ring Seal:** Prevents contaminant bypassing the filtration media under normal operation

**Benefit:** Reliable, consistent filtration performance

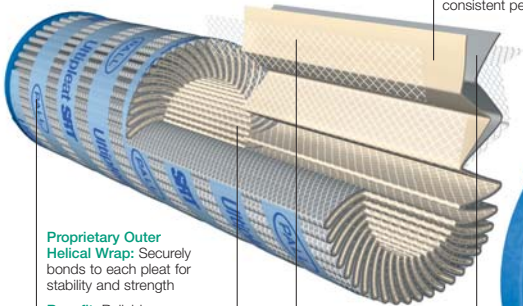

**Proprietary Outer Helical Wrap:** Securely bonds to each pleat for stability and strength

**Benefit:** Reliable, consistent performance and resistance to severe operating conditions

**Up and Downstream Mesh Layers:** Create flow channels for uniform flow through the filter

**Benefit:** Extended element life for lower operating costs

**Coreless/Cageless Design:** Outer element cage is a permanent part of the filter housing

**Benefit:** Lighter, environmentally friendly element for reduced disposal costs and ease of element change-out



**SRT Media:** Inert, inorganic fibers securely bonded in a fixed, tapered pore structure with increased resistance to system stresses such as cyclic flow and dirt loading

**Benefit:** Improved performance over the life of the filter and more consistent fluid cleanliness

### Auto-Pull Element Removal Tabs:

Corrosion-resistant endcaps feature exclusive Auto-Pull tabs for automatic element extraction upon opening the housing

**Benefit:** Ease of element change-out

### Triboelectric Charge Resistant Design:

Element pack composed of materials for minimized triboelectric charge generation and no electrostatic discharges

**Benefit:** No damage to filter element or housing or other system components from electrostatic discharge; minimizes fluid degradation



# Ultipleat<sup>®</sup> SRT

FILTRATION

# Advanced Test Method for Measuring Filter Performance

## Cyclic Stabilization Test\*

### Schematic

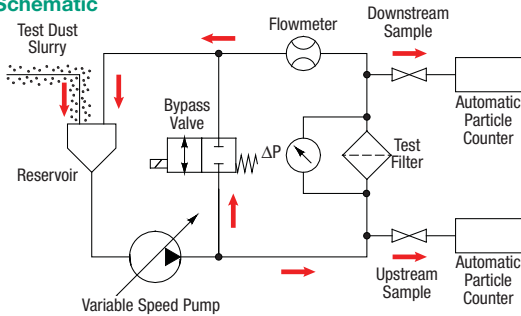

\*based on SAE ARP4205

### Concept:

As opposed to ISO 16889 that only tests filters under steady state conditions, the Cyclic Stabilization test is used to evaluate hydraulic filter performance under typical stressful operating cyclic conditions such as:

- Flow surges
- Pressure peaks
- Cold starts

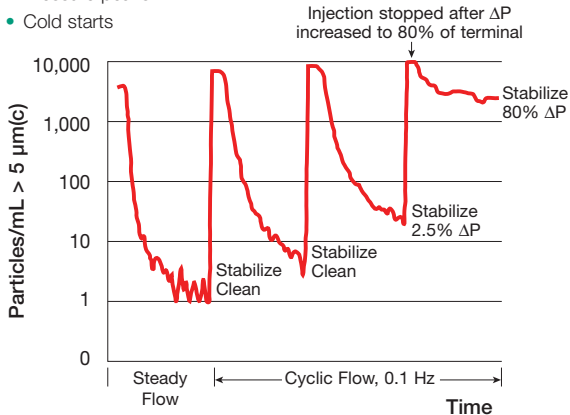

Cyclic Stabilization Test (CST) measures a filter's ability to clean up a contaminated system under cyclic flow (25 to 100 % of rated flow) and contaminant loading conditions

CST ISO 4406 Cleanliness Code ratings are based on the stabilized cleanliness achieved at 80 % of the net terminal pressure drop, considered the worst operating condition

For clarity, only the number of particles/mL >5μm(c) are shown

# Pall Ultipleat® SRT Filter Performance Data

Ultipleat SRT Grade	Cleanliness Code Rating (ISO 4406) from Cyclic Stabilization Test*
AZ	08/04/01
AP	12/07/02
AN	15/11/04
AS	16/13/04
AT	17/15/08

\* based on SAE ARP 4205

## Multi-Pass Filter Rating (ISO 16889)

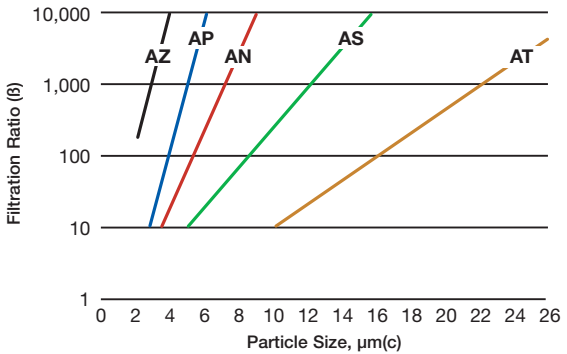

### Traditional Fan-Pleat Filter

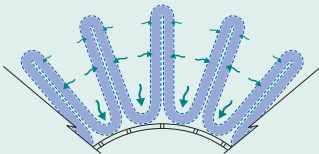

### Pall Ultipleat SRT Filter

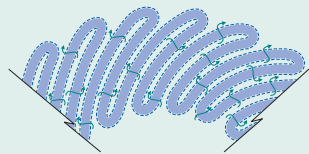

### The optimized pleat geometry of SRT filtration provides:

- Uniform flow distribution and increased flow capacity
- Maximum filter surface area and element life

# Triboelectric Charging Effect on Filtration

## Triboelectric Charging Resistant (TCR) Filters

- Designed to dissipate triboelectric charge build-up
- Produce only minimal triboelectric charging of the fluid (as measured by the fluid charge)
- Minimize fluid degradation and varnish formation



Electrical discharge occurring inside oil tank

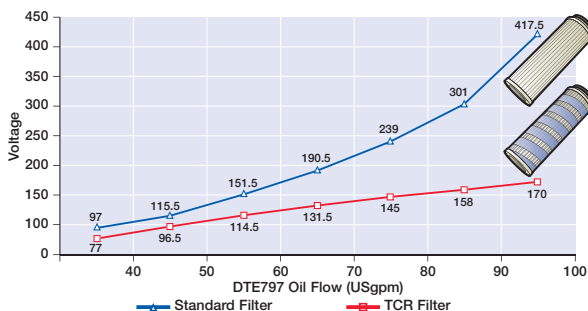

## Filtration & Contamination Standards

ISO 2941	Filter elements - Verification of collapse/burst pressure rating
ISO 3968	Filters - Evaluation of differential pressure versus flow characteristics
ISO 4021	Extraction of fluid samples from lines of an operating system
ISO 4407	Determination of particulate contamination by the counting method using an optical microscope
ISO 11171	Calibration of automatic particle counters for liquids
ISO 16889	Filter elements - Multi-pass method for evaluating filtration performance of a filter element
ISO 18413	Component cleanliness - Inspection document and principles related to contaminant collection, analysis and data reporting
ISO 21018-3	Monitoring the level of particulate contamination of the fluid - Part 3: Use of the filter blockage technique
SAE ARP4205	Filter elements - Method for evaluating dynamic efficiency with cyclic flow

Note: This is a small selection of ISO standards relevant to hydraulic and lubrication applications.

# Differential Pressure Indicators and Switches

Differential pressure ( $\Delta P$ ) indicators and switches notify the operator of the filter condition. This allows a replacement filter to be installed before filter element bypass occurs.

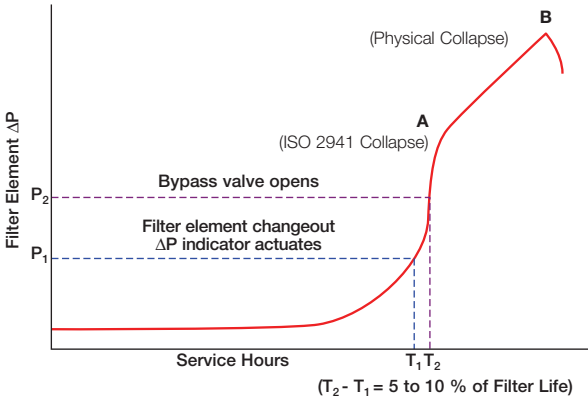

$\Delta P$  across the filter increases as contaminant is trapped within the filtration medium. A  $\Delta P$  indicator actuates at  $P_1$ , signalling the need for element change before the bypass relief valve opens at  $P_2$ . The bypass valve protects the filter and system from excessive differential pressure.

Without a bypass valve, continued operation at higher  $\Delta P$  risks degradation of filtration performance (point A) and filter element collapse (point B) where the integrity of the filter element is lost.

# Differential Pressure Indicators and Switches

## Mechanical and Electrical Options Available

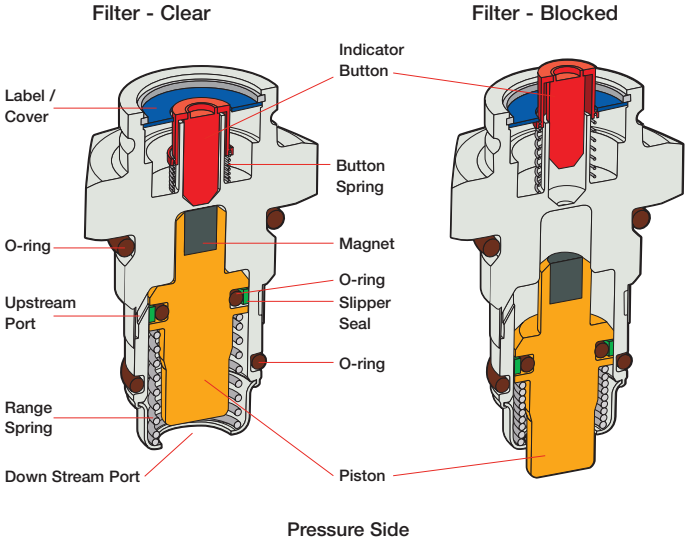

### Technical principle of the mechanical indicators:

Differential pressure indicators operate by sensing the  $\Delta P$  between ports upstream and downstream of the filter element. When the  $\Delta P$  across the internal piston/magnet assembly reaches a preset value, determined by the range spring, the piston assembly moves downward, reducing the attractive force between the magnet and indicator button. The indicator button spring then overcomes the reduced magnetic force and releases the button to signal the need for element change. Activation can be visual using a button as shown here or electrical using a microswitch.

A variety of differential pressure indicator models are available. Contact Pall to determine the most appropriate  $\Delta P$  indicators or switches for your applications.

## Filters for Process Fluids



**Recommended for industrial applications to treat water, fuels, aqueous solutions, and low viscosity process fluids.**

Recognizing that different applications have different fluid cleanliness and filtration requirements, the Pall range of Melt Blown filter products is simply defined to help you choose the best solution at the most economic cost.

### Highly Critical Cleanliness

For applications such as fluid make-up, cleanliness control, polishing or clarification, where the full range of solid contamination removal including silt is required.

### Critical to General Particulate Control

Cleanliness control in wash applications, machining applications where high surface finish is required, single pass in-line last chance filtration applications, and for general purpose fluid clarification.

### General Particulate Control

Coarser ratings for primary or pre-filtration applications, or higher fluid flow applications where a fluid cleanliness level is not specified.

Particulate Control	Efficiency Rating%	Recommended Range (µm)
Highly Critical	99.98%	1, 3, 6, 12, 20
Critical to General	99.9%	40, 70, 90
General	90%	100, 150, 200

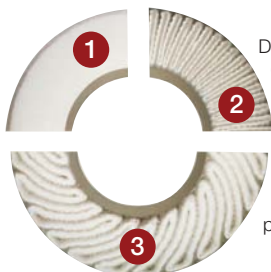

Different medium configurations can be applied to specific user requirements. The Pall filter element range is available in **1** depth, **2** fan pleated and **3** patented laid over pleat (Ultipleat®) designs.

### Applications

- Component wash fluids
- Cutting fluids
- Process fluids
- Water
- Coolants
- Water glycols
- Mineral and synthetic oils
- Lubricants
- Fuels
- Solvents



## Separation Systems for Process Fluids

### Tramp Oil Separator

A unique, patented unit designed to remove free and dispersed tramp oil from metal working and parts washing fluids.

Tramp oil is unwanted oil that has entered into the fluid system, such as hydraulic and lubrication oils from the machine itself or cutting fluids and rust inhibitors that have been carried over on the part from previous processes.



### Crossflow Filtration Systems

Pall Clarisep crossflow filtration systems remove tramp oil, suspended solids and bacteria from water-based fluids to maintain the fluid in optimum condition for extended service life. These systems can also be used to process oily wastewater, minimizing the volumes that have to be disposed of off-site.

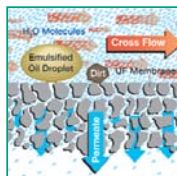
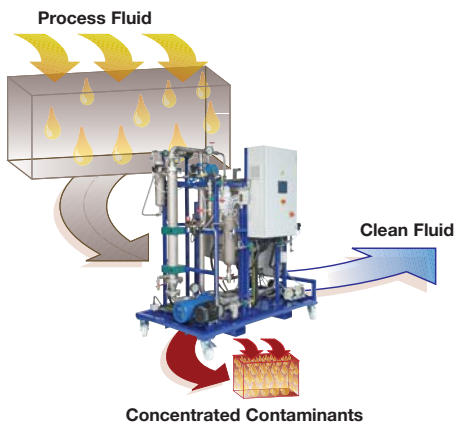

### Pall Clarisep Membrane

Pall crossflow systems direct fluid flow across the surface of a porous membrane.

Emulsified oil and grease, bacteria, fungi and suspended solids are larger than the membrane pores and are, therefore, held back, allowing clean fluid to pass downstream.

Pall offers a range of membrane technologies, allowing the optimum solution to be selected for a specific application. All Pall Clarisep systems automatically regenerate in-situ for extended life.

# Diesel Fuel Purification

## Diesel Engine Fuel Cleanliness Control - From delivery, to storage, to pump, to injector

The latest injection technology for diesel powered engines requires superclean fuels. Fine filtration and liquid/liquid coalescence are strategically required along the diesel supply chain.

### Example of a Basic Mining Fuel Distribution System

#### Fuel Delivery

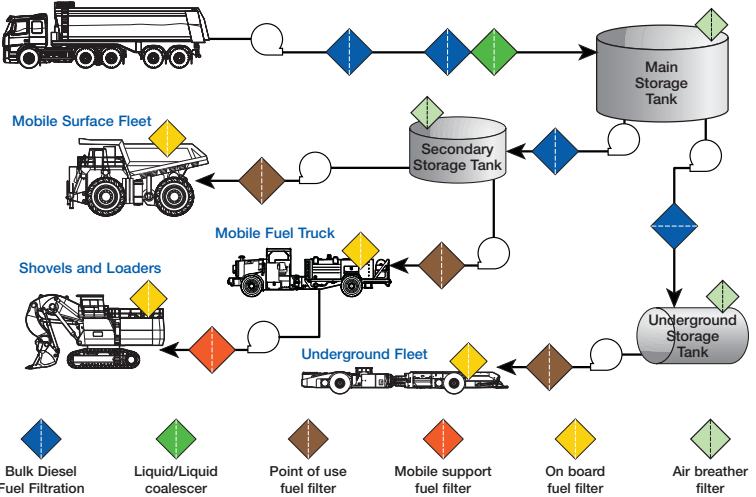

Pall Ultipleat® Diesel Fuel Filter Elements



Pall Ultipleat® SRT Filter Elements



Pall PhaseSep® Coalescers

# Component Cleanliness Management

Component Cleanliness Management (CCM) is a comprehensive program designed to help clients achieve desired component cleanliness. After working with you to validate processes and set cleanliness specifications, the program follows a defined path to assess component cleanliness and identify areas for improvement. We then provide recommendations and assist in their implementation

Design it  
Build it  
Keep it

# CLEAN

## Your route to component cleanliness



### Pall Cleanliness Cabinets

Pall Component Cleanliness Cabinets facilitate the accurate, reliable and repeatable determination of component cleanliness.

- Stainless steel construction
- Controlled extraction environment
- Automated cleaning to “blank” values
- Pressurized solvent dispensing and recycling circuits.
- Meet ISO 18413, ISO 16232 and VDA 19 procedures

## Required Fluid Cleanliness Level Worksheet\*

Selection of the appropriate cleanliness level should be based upon careful consideration of the operational and environmental conditions. By working through this list of individual parameters, a total weighting can be obtained from the graph on page 38, to give the Required Cleanliness Level (RCL).

**Table 1. Operating Pressure and Duty Cycle**

Duty	Examples	Operating Pressure (bar (psi))					Actual
		0-70 (0-1000)	>70-170 (>1000-2500)	>170-275 (>2500-4000)	>275-410 (>4000-6000)	>410 (>6000)	
Light	Steady duty	1	1	2	3	4	
Medium	Moderate pressure variations	2	3	4	5	6	
Heavy	Zero to full pressure	3	4	5	6	7	
Severe	Zero to full pressure with high frequency transients	4	5	6	7	8	

**Table 2. Component Sensitivity**

Sensitivity	Examples	Weighting	Actual
Minimal	Ram pumps	1	
Below average	Low performance gear pumps, manual valves, poppet valves	2	
Average	Vane pumps, spool valves, high performance gear pumps	3	
Above average	Piston pumps, proportional valves	4	
High	Servo valves, high pressure proportional valves	6	
Very high	High performance servo valves	8	

**Table 3. Equipment Life Expectancy**

Life Expectancy (hours)	Weighting	Actual
0-1,000	0	
1,000-5,000	1	
5,000-10,000	2	
10,000-20,000	3	
20,000-40,000	4	
>40,000	5	

**Table 4. Component Replacement Cost**

Replacement Cost	Examples	Weighting	Actual
Low	Manifold mounted valves, inexpensive pumps	1	
Average	Line mounted valves and modular valves	2	
High	Cylinders, proportional valves	3	
Very high	Large piston pumps, hydrostatic transmission motors, high performance servo components	4	

**Table 5. Equipment Downtime Cost**

Downtime Cost	Examples	Weighting	Actual
Low	Equipment not critical to production or operation	1	
Average	Small to medium production plant	2	
High	High volume production plant	4	
Very high	Very expensive downtime cost	6	

**Table 6. Safety Liability**

Safety Liability	Examples	Weighting	Actual
Low	No liability	1	
Average	Failure may cause hazard	3	
High	Failure may cause injury	6	

\* Adapted from BFFA/P5 Target Cleanliness Level Selector 1999 Issue 3.

**Table 7. System Requirement**

Cleanliness Requirement Total Weighting	Total
Sum of 'Actual' weighting from sections 1 through 6	

Using the chart below, determine where the 'Cleanliness Requirement Total Weighting' number from Table 7 intersects the red line. Follow across to the **left** to find the recommended ISO 4406 Code.

**Table 8. Environmental Weighting**

Environment	Examples	Weighting		Actual
		Single Filter	Multiple Filters*	
Good	Clean areas, few ingressions points, filtered fluid filling, air breathers	0	-1	
Fair	General machine shops, some control over ingressions points	1	0	
Poor	Minimal control over operating environment and ingressions points e.g. on-highway mobile equipment	3	2	
Hostile	Potentially high ingressions (e.g. foundries, concrete mfg., component test rigs, off-highway mobile equipment)	5	4	

\* Single filter or multiple filters with the same media grade on the system.

**Table 9. Required Filtration Level**

Filtration Requirement Total Weighting	Total
Add Environmental Weighting (Table 8) to System Requirement Total (Table 7)	

Using the chart below, determine where the 'Required Filtration Level' total in Table 9 intersects the red line. Follow across to the **right** to find the corresponding recommended Pall filter grade.



†Using on-line particle counting

# Common Fluid Power Circuit Diagram Symbols

ISO1219-1: Fluid power systems and components - Graphic symbols and circuit diagrams - Part 1: Graphic symbols for conventional use and data processing applications.

## Cylinders and Semi-rotary Actuators

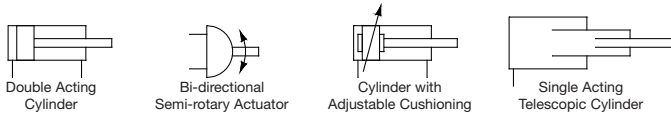

## Pumps and Motors

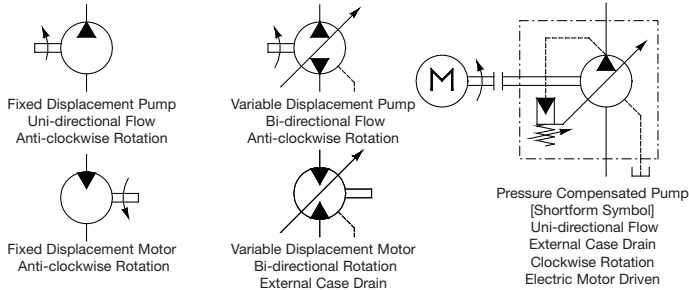

## Directional Control Valves (Unspecified Actuation)

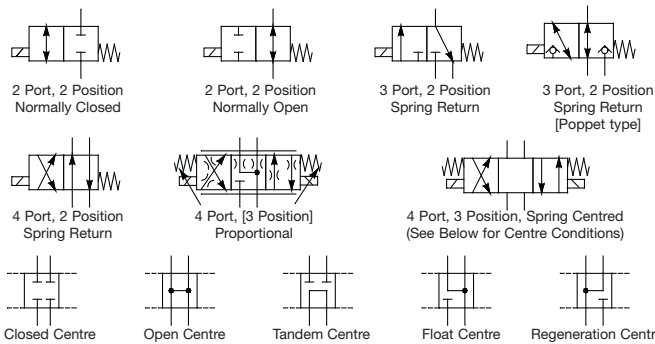

## Directional Control Valve Actuation



## Pressure Control Valves

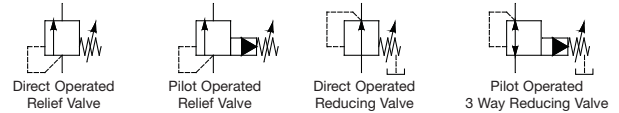

## Isolation and Flow Control Valves

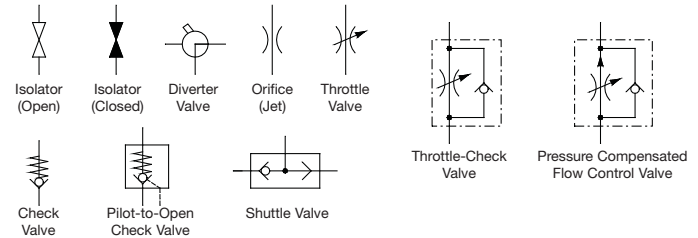

## Filters and Coolers

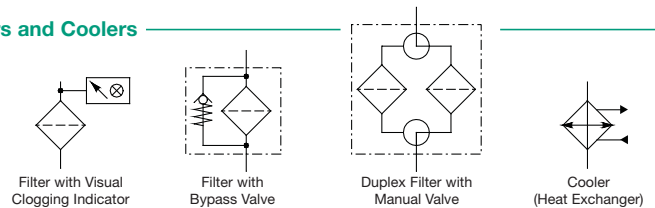

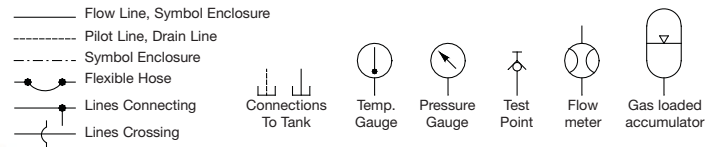

## Instrumentation and Pipeline Components

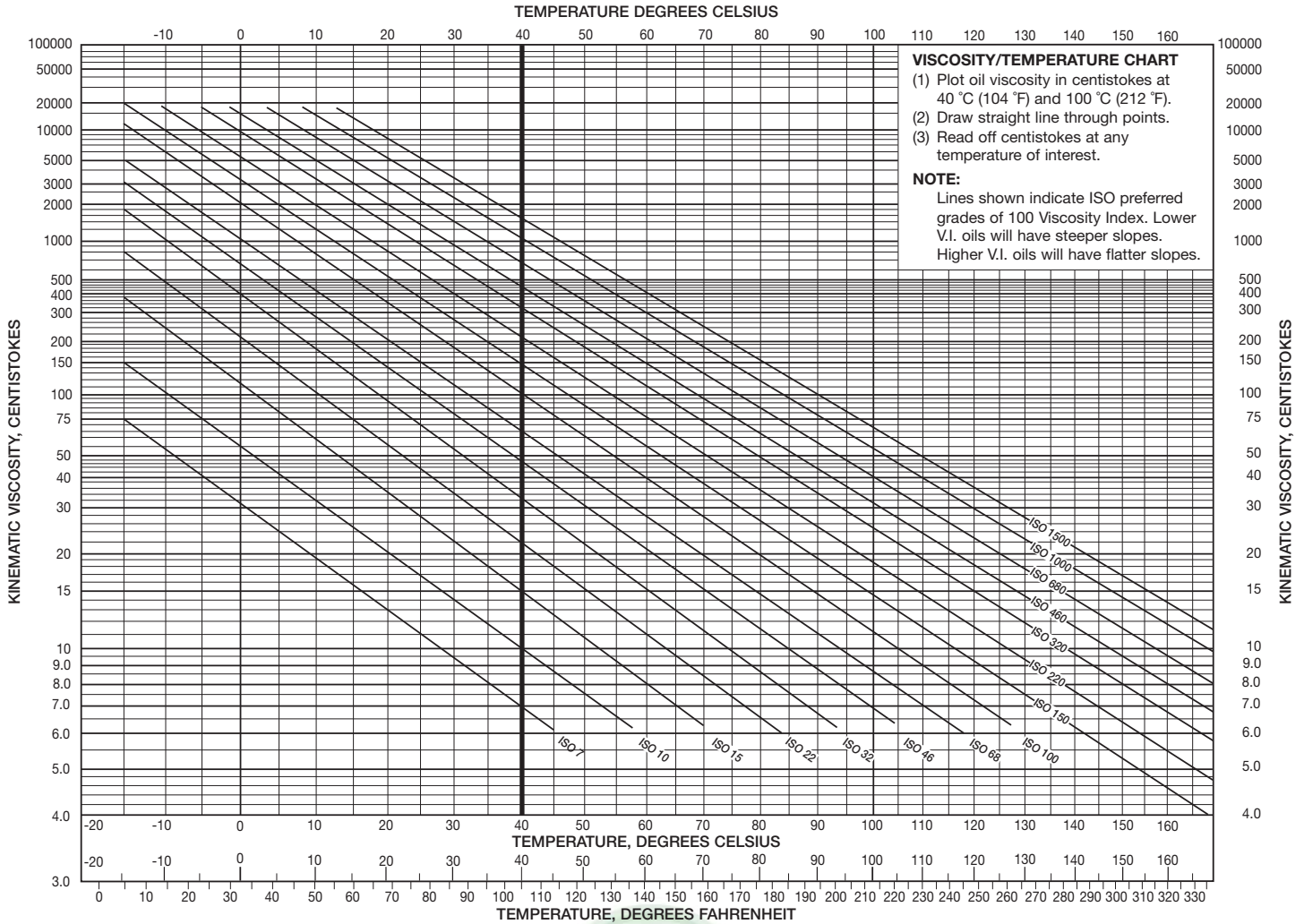



## Measurement Conversion Factors

To convert 	into	Multiply by
 into	To convert	Divide by
Litre	Cubic metre	0.001
Litre	Gallon (US)	0.2642
Litre	Gallon (UK)	0.22
Micrometre (Micron)	Inch	0.000039
Foot	Inch	12
Inch	Millimetre	25.4
Metre	Foot	3.28
Metre	Yard	1.09
Mile	Kilometre	1.609
Litre/sec	Cubic metre/min	0.06
Metre/sec	Kilometre/hour	3.6
Kilogram	Pound	2.205
Pound	Ounce	16
Kilowatt	Horsepower	1.341
Kilowatt	BTU/hour	3412
Atmosphere	PSI	14.7
Bar	PSI	14.5
KiloPascal	PSI	0.145
Bar	KiloPascal	100
Bar	Inches of mercury (Hg)	29.53
Inches of Water	Pascal (Pa)	249
Celsius (Centigrade)	Fahrenheit	$^{\circ}\text{C} \times 1.8 + 32$
Degree (Angle)	Radian	0.01745

To convert units appearing in column 1 (left column) into equivalent values in column 2 (centre column), **multiply** by factor in column 3.

**Example:** To convert 7 Litres into Cubic Metres, multiply 7 by 0.001 = 0.007.

To convert units appearing in column 2 (centre) into equivalent values of units in column 1 (left column), **divide** by factor in column 3.

**Example:** To convert 25 psi into bar, divide 25 by 14.5 = 1.724.





ENABLING A  
GREENER  
FUTURE<sup>SM</sup>

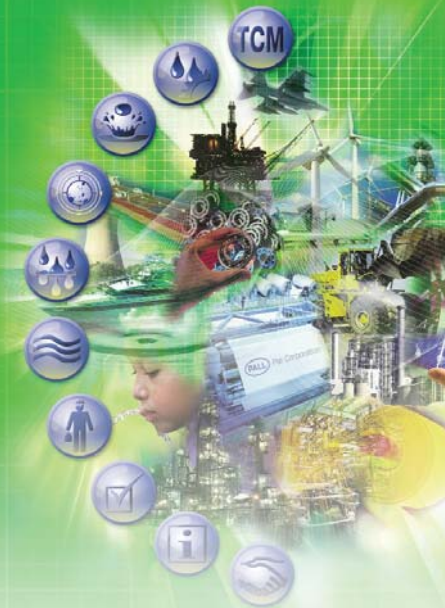

Pall Corporation

#### Pall Aeropower

25 Harbor Park Drive  
Port Washington, NY 11050  
+1 516 484 3600 telephone  
+1 800 289 7255 toll free US

Portsmouth-UK  
+44 (0)23 9230 3303 telephone  
+44 (0)23 9230 2507 fax  
industrialeu@pall.com

#### Visit us on the Web at [www.pall.com](http://www.pall.com)

Pall Corporation has offices and plants throughout the world. For Pall representatives in your area, please go to [www.pall.com/contact](http://www.pall.com/contact)

Because of technological developments related to the products, systems, and/or services described herein, the data and procedures are subject to change without notice. Please consult your Pall representative or visit [www.pall.com](http://www.pall.com) to verify that this information remains valid. Products in this document may be covered by one or more of the following patent numbers: EP 0 930 926; US 5,480,547; US 6,332,987; EP 0 667 800; EP 0 982 061; EP 1 380 331; US 5,543,047; US 5,690,765; US 5,725,784; US 6,113,784; US 7,083,564; US 7,318,800; EP 0 667 800; EP 0 982 061; EP 1 380 331; US 5,543,047; US 5,690,765; US 5,725,784; US 6,113,784; US 7,083,564; EP 1 656 193; EP 0 470 485; US 5,252,207; US 5,552,048; EP 1 105 201

© Copyright 2011, Pall Corporation. Pall, , Phasesep, Ultipor and Ultipleat are trademarks of Pall Corporation.

® indicates a trademark registered in the USA.

ENABLING A GREENER FUTURE and *Filtration. Separation. Solution.*<sup>SM</sup> are service marks of Pall Corporation.